

# Your Baby & Toddler Group Companion

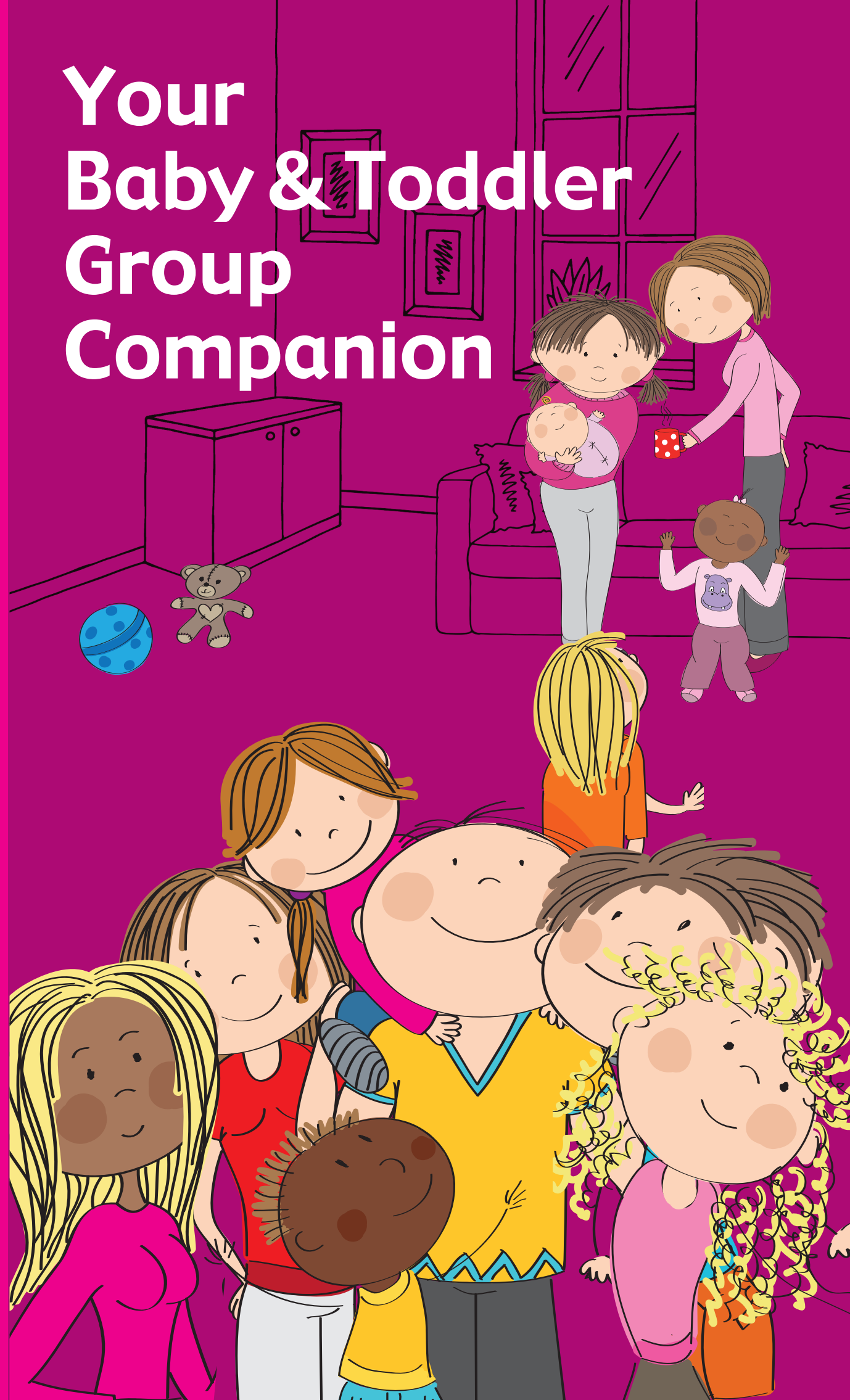

**abc start RIGHT LIMERICK**

**PAUL PARTNERSHIP LIMERICK**  
Supporting the life of entrepreneurs  
by social capital and opportunities  
**PÁIRTÍOCHT PAUL LUIMNEACH**

**Limerick Childcare Committee**

**PARENTING limerick**

**Limerick Social Service Council CLG**  
Comhairle Sheirbhís Sóisialta Luimnigh CLG

**Incredible Years LIMERICK**

**An Roinn Leanaí agus Gnóthaí Óige**  
Department of Children and Youth Affairs

**TÚSLA**  
An Ghníomhaireacht um Leanaí agus an Teaghlach  
Child and Family Agency

**HE** Feidhmeannacht na Seirbhíse Sláinte  
Health Service Executive

# A big thank you

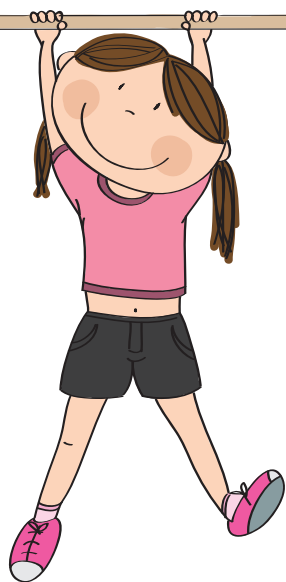

to all of the children, parents and carers in Limerick who attend **Baby and Toddler groups** on a weekly basis. Your experience and voice has guided this resource.

Also, thanks a million to our partners and co-pilots in parenting support:

- Limerick Social Service Council  
Community Mothers and Family Support Initiative
- Barnardos Homemakers Family Support Service
- St Munchin's Community Centre
- Garryowen Community Development Project,  
Parent and Child Home Visiting Programme
- Pery Square 'Park & Play'
- Tusla, The Child & Family Agency
- ABC Start Right
- Hospital Family Resource Centre
- Croom Family Resource Centre



## A little note:

While every effort has been made to ensure the accuracy of the information, PAUL Partnership CLG/ABC Start Right cannot accept any responsibility for mistakes, omissions or loss caused to any person acting or not acting as a result of any information expressed in the Baby & Toddler Group Companion.

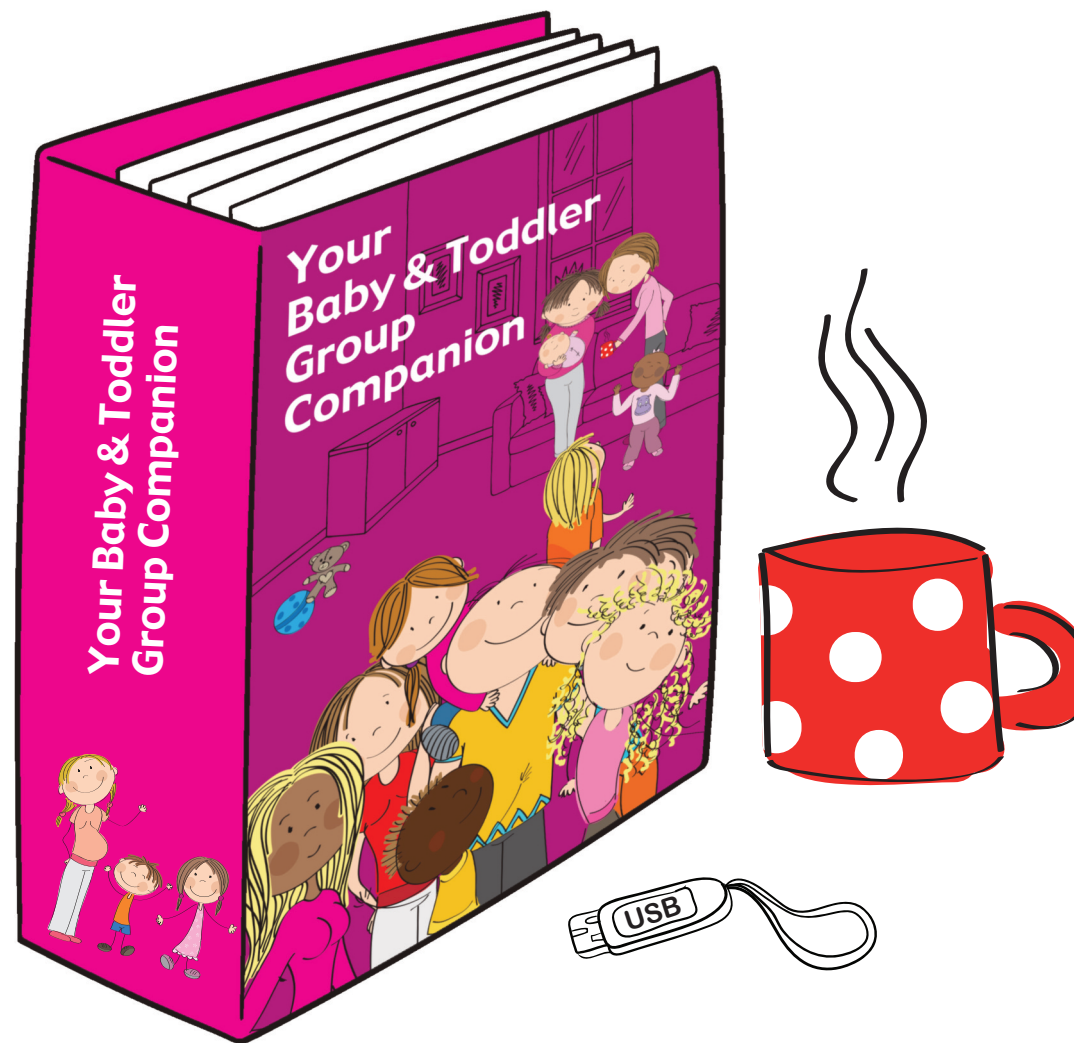

Your Baby & Toddler Group Companion

Foreword  
Contents  
Introduction

Getting Started  
Step-by-Step  
4



Running a Group  
14



Play  
36



Know your Boundaries  
50



Policies & Procedures  
56



# Foreword

Throughout Limerick City and County, there are more than 50 Baby and Toddler groups. Some of these groups are parent-led and others are supported by agencies but all have one thing in common – every week they provide a welcoming and lively space for parents and children to gather and grow. The Baby and Toddler groups are a springboard to so many other supports (workshops, parenting programmes etc.) and have a really important role in sign-posting parents and carers to other services and agencies.

Your **Baby and Toddler Group Companion** is both a strategic and timely resource. Tusla's Prevention, Partnership and Family Support (PPFS) programme works with partners in local communities to support both parents and children to reach their full potential. It reflects that partnership as it is the culmination of ongoing collaborative working between Tusla, ABC Start Right and Parenting Limerick. The strongest voices, however, are those from the many parents, carers, babies and toddlers that opened up their groups to inform the contents and direction of Your Baby and Toddler Companion.

Your **Baby and Toddler Group Companion** isn't intended as a prescriptive guide or manual. It sets out best practice for setting up and maintaining happy and safe Baby and Toddler groups. It offers suggestions and practical ideas that support quality practice because we recognise the diverse needs and priorities of each individual group. We all know that it takes a village to raise a child. Local Baby and Toddler groups are a way for parents and carers to find that village.

Dr. Caroline Cullen  
Tusla Area Manager, Mid West



# Introduction

This companion is an attempt to answer commonly asked questions by parents, carers, facilitators and others who may be interested in setting up and sustaining a fun, friendly, stimulating, safe and supportive Baby & Toddler Group.

The information provided within is merely a guide. Parents, carers, facilitators and groups are encouraged to use the information as they need it, as a support to what they may be already doing, or to try something new.



A USB memory stick has been provided with this guide. On it you will find sample policies, editable documents and supplementary information to help support your Baby & Toddler Group.

When you find this symbol throughout the guide, it means that there is relevant information in the accompanying USB memory stick.

## About Baby & Toddler Groups

A Baby & Toddler Group is run by an organisation or voluntarily by parents/carers to arrange get-together sessions for children and their carers and provide:

- The opportunity to meet other families
- An open and friendly environment to have a chat
- Positive opportunities for parents/carers to be supported in parenting
- An opportunity to play and interact with children in a different setting

## Benefit to children

- Play and have fun
- Learning through play
- Learn new language
- Make new friends

Groups tends to be open and relaxed with decisions taken by members. Most groups are very informal, and this is often key to their success.

## Creating and maintaining a supportive and stimulating environment for parents/carers



## Introducing Baby & Toddlers Groups to parents

You matter! Try to take some simple measures to ensure that the needs of parents/carers are central to the group – **never underestimate the power of a cup of tea or coffee!**

The expectations and realities of parenthood can be quite different. Plans for maternity or parental leave usually include leisurely days where yourself and your sleepy newborn will finally have the time to catch up with friends, household projects and all those other things that have been on the long finger for so long. There will be, without a doubt, plenty of those lazy, hazy days.

There are also other days; the ones where a shower is like a gift from the gods and getting dressed feels like a major achievement. You realise that time isn't your own because there's a new (tiny) sheriff in town and that you haven't had a conversation with a grown-up all day. This is where a local Parent and Baby/Toddler group can throw you a lifeline.

As the name suggests, these groups benefit both parent/carer and child. While your baby or toddler has an opportunity to interact with babies of similar age and developmental stage, you can enjoy a chat with other parents/carers and pick up some very helpful information and tips from that peer group, as well as from the group leader.

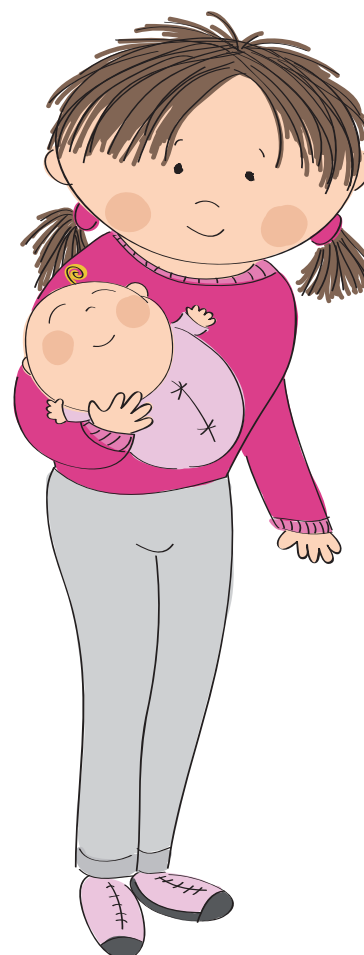

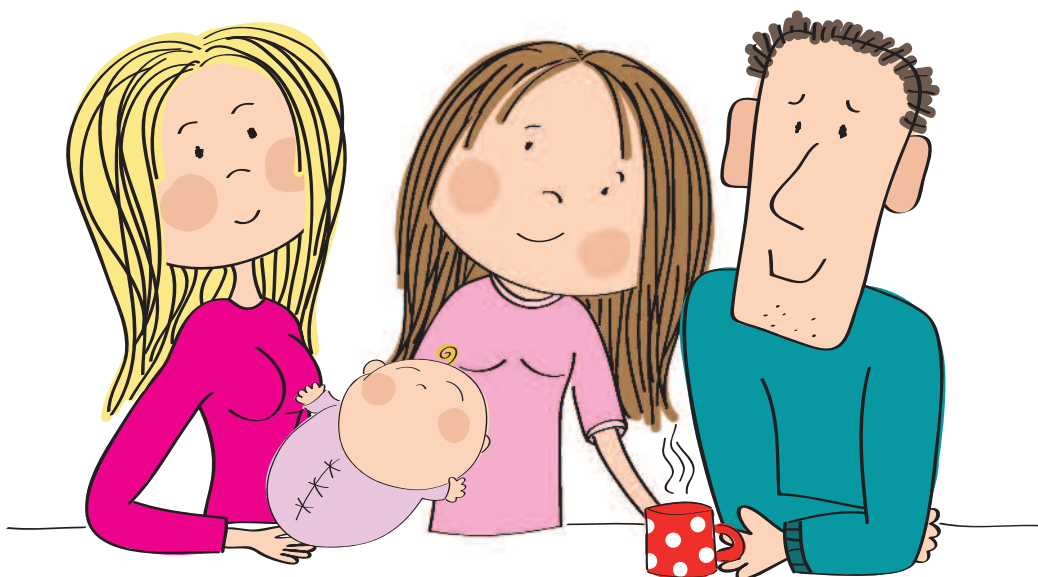

They provide a weekly space that has a subtle structure – for example, free play, craft activity, tidy-up, snack, story and song – and which allows both you and your child to meet friends, explore new things and learn.

The group provides a weekly window, usually for 60-90 minutes, where you can meet with others who understand exactly where you are at this particular point of parenthood. Suggestions for dealing with sleepless nights, easing the pain of teething, sibling rivalry and finding time for yourself are generally always points of discussion.

The sessions also provide a great opportunity to see developmental milestones in action. Your baby, for example, might be a newborn but there may be a mom with a 3-month old in the group, or a dad with a 9 month-old who is crawling. It's fascinating to see what lies ahead and again, to pick up some ideas from other parents/carers.

For some parents, grandparents and carers, the weekly catch-up and opportunity for children to play and make new friends is enough. For others, the understated hand-holding and support makes them that bit more confident in their parenting role. Which ever you are, it doesn't matter; if you are caring for a baby or toddler, these groups are a welcoming and supportive place for you.

For locations and times of  
Baby/Toddlers group in  
Limerick, check  
[www.loveparenting.ie/supports](http://www.loveparenting.ie/supports)

 LOVEPARENTING.IE



# Getting Started: Step-by-Step

**The simple steps outlined are designed to help you get your Baby & Toddler Group off the ground!**



# Section 1

## Setting up a group - key things to think about

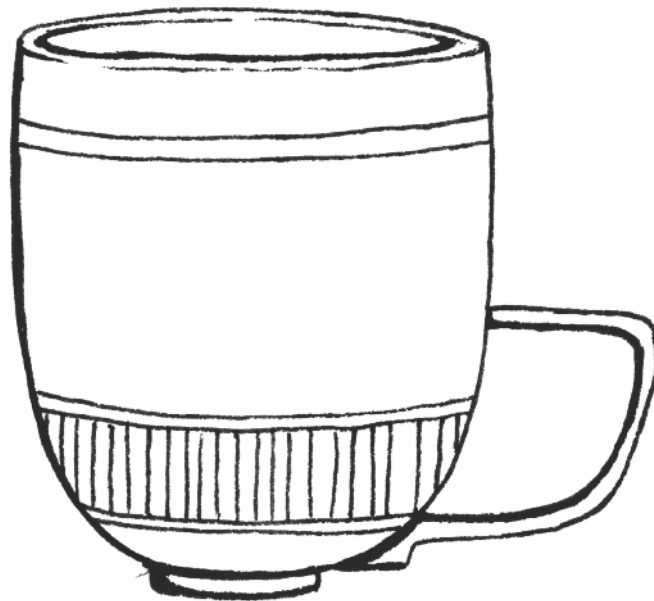

**1 Identify other local groups**  
Are there other local Baby & Toddler groups?  
Can you visit to see how they are run?



**2 Organisation of the group**  
**Two types of Baby & Toddler groups:**  
1. **Facilitator-led:**  
Run by organisations with a support person  
2. **Parent-led:** Run by parents for parents



**3 Selecting a location**  
• Availability  
• Suitability  
• Accessibility (e.g. can you fit many buggies?)



**4 Insurance**  
The group will need public liability insurance



**5 Finance & Funding**  
• Set-up costs such as toys, equipment and insurance  
• Running costs such as weekly room hire, heating etc.  
• Sources of income such as grants, fees  
• Talk to your local Childcare Committee around possible funding opportunities



**6 Promoting the group**  
• Local paper or radio, parish newsletter,  
• Letter to parents sent home via the local schools  
• Posters in local shops, and post office  
• Social media and websites:  
**LOVEPARENTING.IE**



**7 Linking with Tusla**  
Get in touch with the Parenting Support Programme so they can send parents your way



**Health & Safety**  
• A safe venue  
• Fire safety and drills  
• Contact details for all attending  
• Accident/Incident book & first aid box

**8**

## step 1

# Find out if there is a Baby & Toddler Group in your area already

Maybe arrange to pop in so you can see how they are run and what the parents like/expect. Rather than creating competition, having a few groups in an area gives parents more choice and more things to do.

Work together to see how the two groups can compliment each other (e.g. share resources, joint outings etc.)

## step 2

# Organisation of the group

### Two types of groups:

**1. Facilitator-led:** Run by organisations with a support person

**2. Parent-led:** Run by parents for parents



### Decide on how the group is to be structured

This can be as simple as deciding whether one person or a committee takes on the task of organising the group.

The major advantage of a committee is that by sharing the work no one person is left to do it all and it can also provide continuity if a key member leaves.

Holding an Annual General Meeting (perhaps every January) may be a useful way of ensuring the stability of the group.

### Establish the purpose of the group

When setting up a Baby & Toddler Group it is useful to consider the purpose (why is it being set up and what do you want to achieve?)

Most parents attend such groups for the benefit of their children but there are also benefits to be gained for the parents.

When deciding about the purpose of a Baby & Toddler Group it is worth taking time out to develop a Mission Statement, Aims and Objectives in order to clearly identify the underlying philosophy of the group. This will also be of benefit to the group when it applies for funding.

Not all groups will develop a mission statement in the early stages but as time progresses they may feel this would be of value.

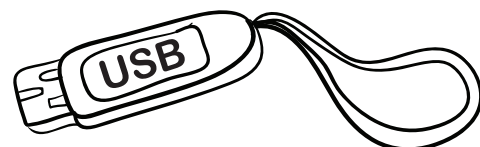

## step 3

# Selecting a location

## Availability

Look out for a suitable space with regular availability, for example:

- 1 A community centre or parish hall
- 2 A room in a health centre
- 3 A sports hall
- 4 A band or school hall
- 5 A Family Resource Centre
- 6 A purpose-built room in existing childcare or crèche facilities

## Suitability

It is important when researching premises that thought is put into its suitability.

Some factors to consider are whether the space is:

- **Welcoming**
- **Available**
- **Accessible**  
Does it include disability/buggy/pram access and parking?  
Is there access to an outside play area or local park?
- **Insurance**  
Is the building covered by public liability insurance?
- **Cost**  
Is there a fee for room rental?  
Is there a cost for heating the room?
- **Cleanliness**  
Is the building well maintained?  
Does it include an appropriate space for nappy changing?  
Are there provisions for clean-up after activities such as arts and crafts?
- **Storage**  
Is there adequate space for secure storage of toys and other equipment?

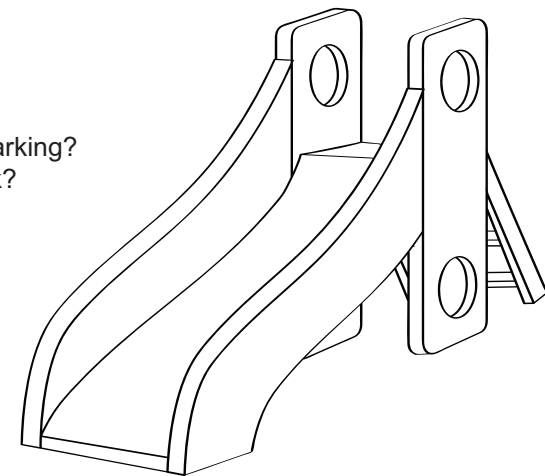

# step 4

## Insurance

Your group will need to take out **public liability insurance**. There are two ways to approach this:

1

In the case of an **independent group**, the group must take out its own policy.

2

If the Baby & Toddler Group is part of a **bigger organisation** (e.g. a Family Resource Centre or childcare service), they may be able to have the Baby & Toddler Group named on their policy.



Always check with your insurer to confirm that all activities conducted by the group are covered, including once-off events/outings (e.g. group visits to playgrounds or play centres).

# step 5

## Finance & Funding

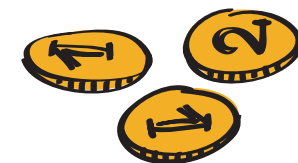

Before considering how to finance the group, it is important to think about the amount of money required to establish and run the group from session to session.

The initial costs may be the largest and could incorporate a budget for toys, insurance, equipment etc. Bear in mind that a little goes a long way.

You could ask members to bring along toys, books or equipment that they no longer have a use for at home: All donations welcome as long as they are clean and in good working order!

Typical sources of funding include the following:

### Weekly contributions

You could decide whether members should make a contribution each session.

#### If so, how much?

Contributions could cover the running costs of the group (e.g. insurance, room rental, art and craft materials, tea, coffee, juice etc.).

Typical ongoing running costs may be rent or room hire, heating, tea/coffee & juice/snacks.

### Remember:

It's important to ensure that any contribution is pitched at a level that is affordable to all members in the community.



### Funding sources:

Contact your local Childcare Committee as they make available a small funding grant for Baby & Toddler groups annually.

Limerick Childcare Committee, Lower Ground Floor, Croom Mills, Croom, Co. Limerick.

Tel: 061 600 918

Email: info@limerickchildcare.ie



### Once-off costs may include:

Outings/trips, attending seminars or hiring guest speakers, as decided by the group.



## step 6

# Promoting the group

There are several ways promote to the group. Some suggestions include:

- Placing notices in the local paper or radio, parish newsletter, libraries, doctor's surgeries or local Health Centres
- Word of mouth
- Letter to parents sent home via the local schools
- Posters in local shops, and post office
- A Facebook page
- Promotion on [loveparenting.ie](http://loveparenting.ie)



## step 7

# Notify Tusla

At present, you are not required to notify Tusla of the existence of your group, but it may be a good idea to do so.

Touching base can provide a contact point for new parents in your area. An additional benefit is that your Baby & Toddler Group may also avail of help under the Parent Support Programme.

Groups can be logged with the Parent Support Programme of Tusla by contacting

Prevention, Partnership and Family Support,  
HSE Building, Raheen, Ballycummin, Limerick.

Tel: 061 483 592 or 483 455



## step 8

# Health & Safety

The health, comfort and safety everyone attending a Baby and Toddler Group is not only important, but it is the responsibility of all members. While most incidents can be prevented, it is not possible to avoid them all.

It's important that your chosen location complies with safety and fire regulations (e.g. identifiable fire exits, presence of fire extinguishers/blankets etc.).

The primary things to consider are:

- 1 The safety of the space/building
- 2 Fire safety and drill
- 3 Incident book to record any incidents or accidents as they occur
- 4 Well-stocked first aid box, see below.
- 5 Emergency contact details for next-of-kin of all the parents attending. These are usually included on your registration form.

## Basic First Aid Box Contents

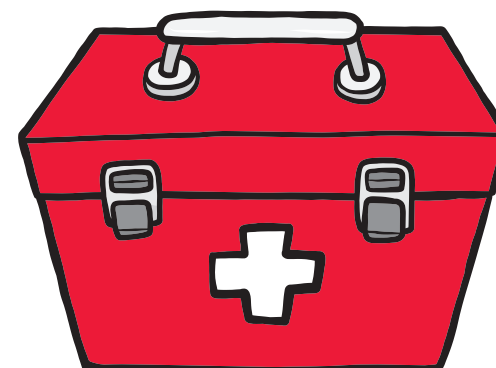

Hypoallergenic plasters and tape

Sterile eye pads

Individually wrapped bandages

Small, individually wrapped, sterile, un-medicated, wound dressings

Individually wrapped antiseptic wipes

Paramedic shears (or scissors)

Latex gloves

Sterile eye wash (bottled or running water will suffice)

Safety pins

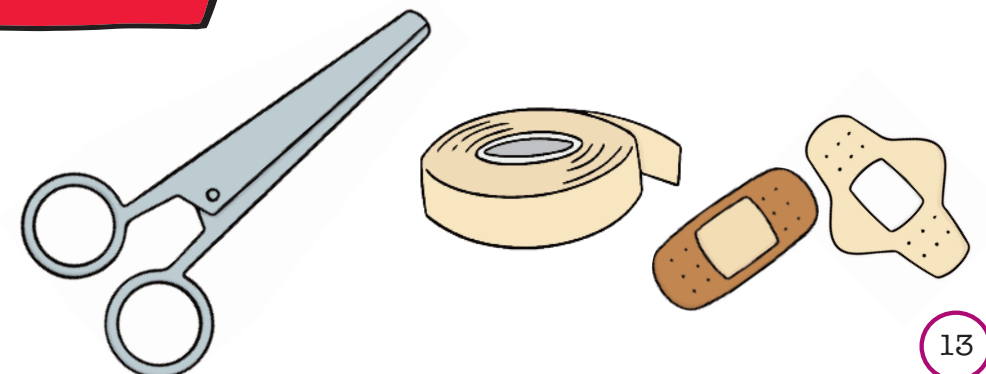

# Running a Group

Without running yourself  
into the ground



step  
1

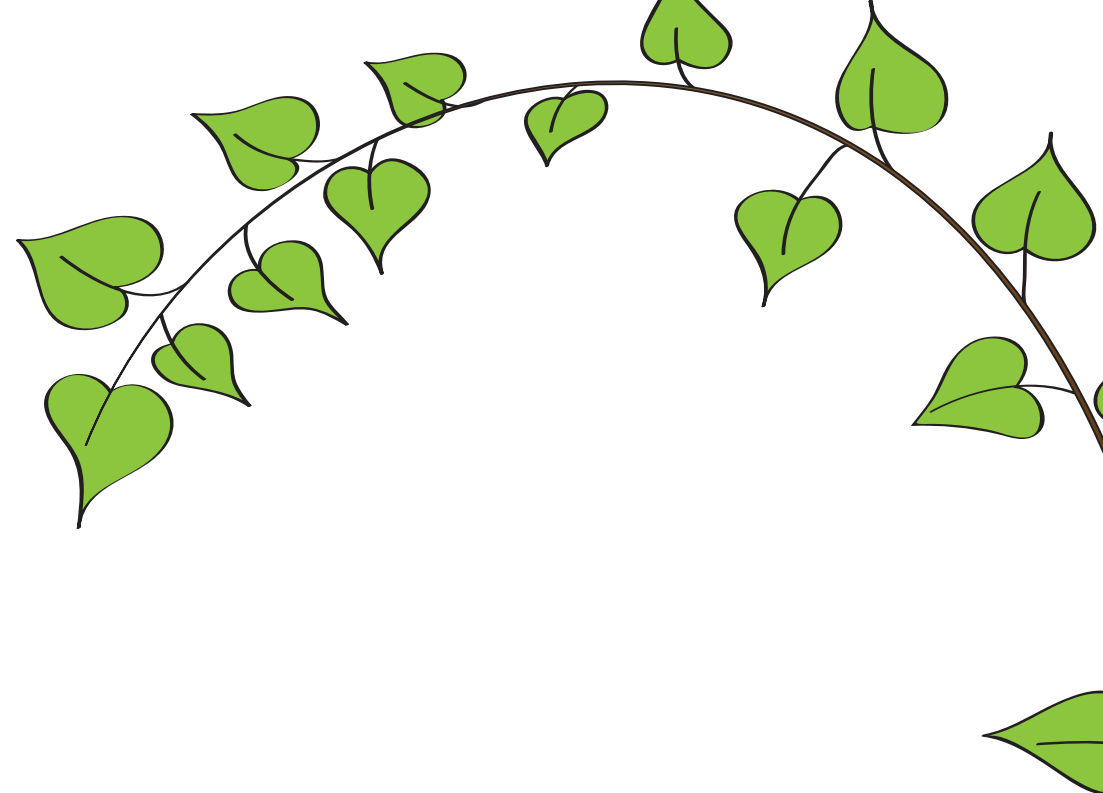

# 1 Group planner/organiser(s)

(up to three different people could share this job):

**Duties include:**

**Venue**

- Book the venue
- Look after keys to open and lock up.

**Finance**

- Look after the basic finances
- Leave a basket/jar for fees in a designated place each session
- Record income and expenditure.

**Safety**

- Take responsibility for
- Stocking and maintaining the contents of the First Aid Box
  - Organising/ conducting a safety audit on the space used
  - Reducing or removing potentially harmful features (e.g. fitting socket covers)
  - Arranging fire drills or keeping an eye on actions which might lead to accidents within the group (e.g. spills)
  - The safety person should also record and maintain an Accident/Incident Book or assist in the completion of Accident/Incident Forms with the parties involved.

# 2 Welcome & Information Person(s)

**Duties include:**

- Greet and introduce everyone on arrival
- Oversee the attendance sheet
- Ensure all new members get the basic information about the group, get a welcome letter and have completed a registration form.

# 3 Play Planner

**Duties include:**

- Plan and set up the play activities, e.g. water tray or play dough table
- Lead the story-telling and nursery rhymes, or support other parents to lead an activity.

**Everyone attending the group takes responsibility to clean, and wash up.**

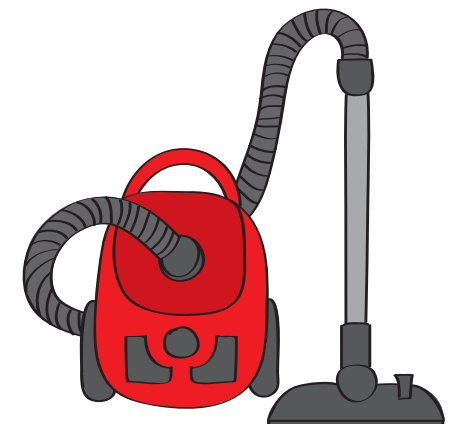

# Programme Planning

Many Baby & Toddler groups operate very relaxed and informal programmes, where play is unstructured, and children and parents/carers are free to decide on the types of activity and their level of involvement at each session.

Baby & Toddler groups are ideal settings for parents/carers to actively and jointly plan activities that will enhance and increase their child's confidence and development.

A programme plan could prove highly beneficial to Baby & Toddler groups that wish to get as much as they possibly can from their time together.

Programme planning has many benefits, because it can:

- 1 Promote variety
- 2 Encourage shared responsibility
- 3 Support the future sustainability of the group
- 4 May be of assistance in deciding the budget required
- 5 May be useful in providing support material for funding applications.

# Programme Plan



**Free play on arrival:**  
Set up in a number of play areas e.g. kitchen with playdough, sand pit, block and building, reading corner etc.

**Activity Spider making:** set up at the art table

**Song and rhyme time**

**Story time to finish**

**Everyone helps with clean-up**

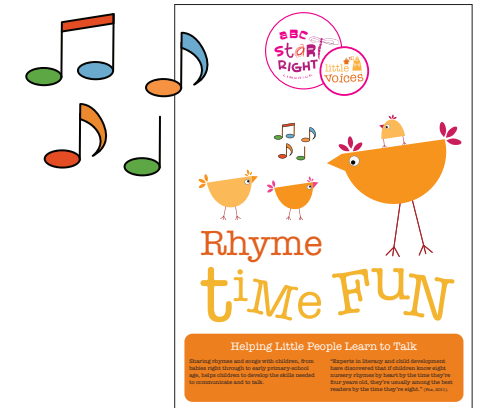

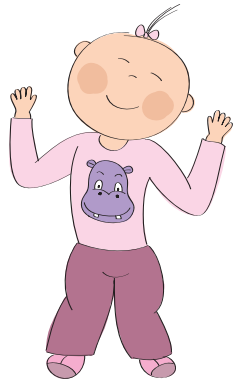

## Child-focused

**When developing a programme plan for children, it is important that the programme:**

- Is age appropriate and takes account of babies, toddlers, pre-schoolers etc.
- Is varied and diverse (art & craft, physical activity, music & drama etc.)
- Meets the needs of the children (structured & unstructured play opportunities)
- Is built on the talents, skills and strengths of the group e.g. parents/carers

**Examples include:**

- baby massage
- play & music sessions
- arts & crafts
- teddy bear's picnic
- healthy eating lunch
- Halloween (or seasonal) party etc.

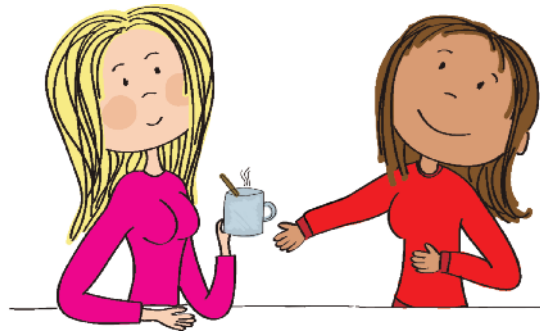

## Parent-focused

**When developing a programme plan for parents, it is important to consider:**

- The interests of parents
- Their availability:
  - Some speakers may work well in the weekly session, others may work better in an evening session
- Other requirements e.g. childcare, transport etc.
- Guest speakers on topics relevant to parents e.g.
  - paediatric first aid
  - child development
  - oral language development
  - managing behaviour
  - promoting healthy choices/nutrition
  - managing time etc.



## step 2

## Running a happy group (Our Code)

It's a good idea to spend some time agreeing a Code of Behaviour or Group Charter to help ensure the smooth running of the group. This may pre-empt any unnecessary ill feeling developing. Some suggestions you might include:



**Tip:** If it is not practical to do this kind of work during group time, with children present, consider taking some time out (perhaps in the evening or during a weekend) to tease out your code. Consider revisiting your code annually, as people and priorities may change.

**Tip:** A copy of your code could be included with your standard welcoming letter.



# step 3

## Health & Safety

Before sessions start, you should set about identifying any health and safety hazards, remove them where possible and reduce them if they cannot be eliminated. Think about how you "child proof" your own home and apply as appropriate.

**Remember** to get down to a child's level to see things as they do.

Think about the child's view and crawl around the space used by the group.

Remove any hazards or items of concern or hazards.

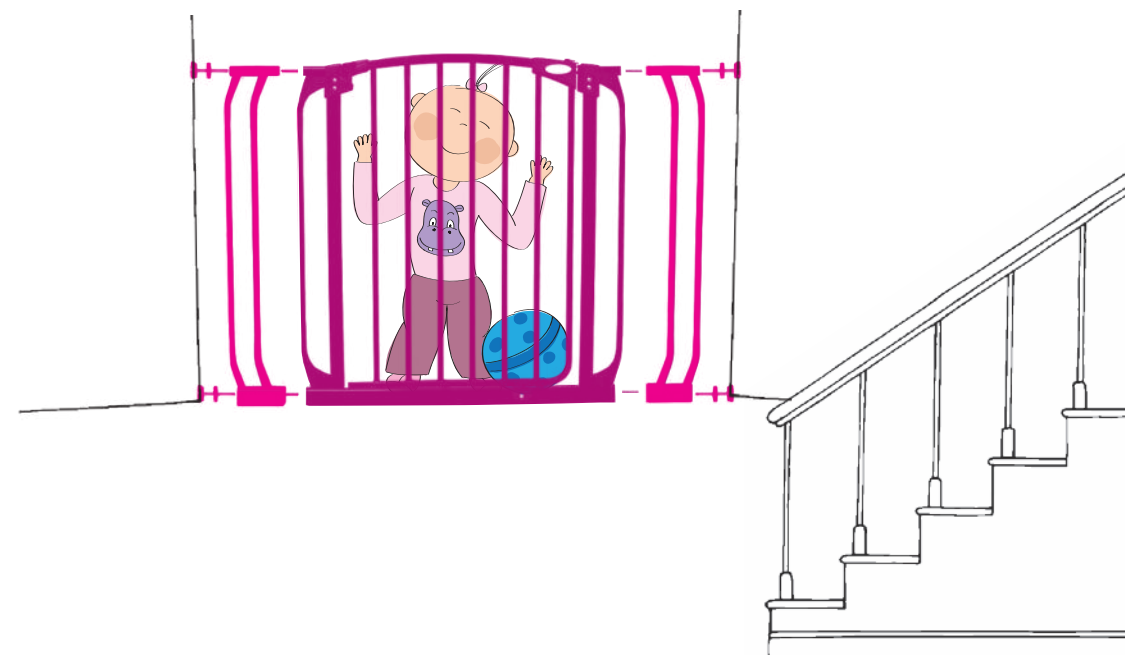

You know babies and toddlers - if it's dangerous, they will find it!



## Suggested Resources, Toys & Equipment

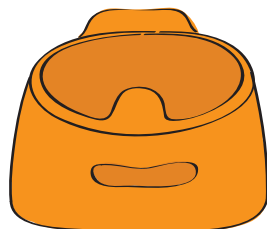

Tea and coffee-making facilities:

- cutlery
- cups
- child friendly beakers

Changing facilities, in a close but separate area from the group

Equipment to assist young children to go to the toilet, such as:

- potties
- specially fitted toilet seats
- booster steps

Security gates to prevent children from leaving the space and block access to stairs or steps

A designated safe area for babies, with:

- soft flooring
- soft toys
- light rattles
- mobiles
- activity centres etc.

Think about different areas

Chairs, cushions, or bean bags for adults and children to sit on.

A couple of tables, as required for tea and coffee, registration etc.

A selection of items for toddlers and older children:

- sit and-ride toys
- dolls
- a toy kitchen
- cuddly toys
- a garage with cars
- prams
- buggies
- wooden jigsaws
- building blocks
- dress-up clothes
- colourful books
- playdough
- coloured paper
- card, paint, crayons
- safety scissors
- blackboard & coloured chalks etc.

A cordoned off area for crawlers with, for example:

- cars
- dolls
- cloth books
- shape sorters
- roll along toys
- coloured blocks etc.

## Basic equipment

## Consider the following:

1

### Include

- Socket covers
- Locks on doors, windows, drawers and cupboards
- Safety precautions on low level windows, patio doors, glass panels
- Gates at top and/or bottom of stairs
- Clean, undamaged, age-appropriate toys that comply with safety marks.

2

### Remove/Safely store

- Electrical equipment leads such as kettles and heaters
- Toxic substances and cleaning products
- Damaged or dirty toys and equipment.

A full safety check can be found on the USB memory stick.



## Sample Health & Safety Plan

### Fire safety policy

All parents/carers sign in for themselves and their child/ren at the start of each session.

**Signing-in is important** - in the event of a fire or fire drill we need to know everyone is safe and accounted for. Fire drills provide us with opportunities for trial runs and preparation for anything that might happen.

We hold fire drills regularly, at least ..... (number) times a year.



## Fire Drill

We will take the following action in the event of a fire:

- Raise the alarm immediately
- Evacuate the premises immediately
- Dial **999** or **112** and request the Fire Brigade
- Stay calm and give the necessary particulars
- Stay on the phone until the operator tell you to hang up.

## Evacuation plan

Our pre-arranged assembly point outside of the building is

(details)

(The building should have a clearly marked gathering point).

In the unlikely event of an emergency:

- 1 Exit the premises, taking the sign in book (assign a person to ensure this is brought outside when evacuating)
- 2 Do not stop to collect personal belongings
- 3 Close all the doors behind you
- 4 When outside, ensure that everybody is safely away from the building at the prearranged assembly point
- 5 Do not leave the assembly point until a head count with your signing in book/attendance login is completed
- 6 Do not re-enter the premises until we are told it is safe to do so.

**Note:** All group members are responsible for ensuring that nothing blocks exits. All escape routes must be kept clear at all times.

## Infection Control

We would ask all participants to skip group in the unfortunate event that a parent/carer or child are not feeling well, e.g. the common cold, stomach bugs flu, measles, mumps, chicken pox, head lice etc.

We will:







- Maintain a high standard of hygiene. Ensure toys and equipment are washed regularly
- Have a supply of hand soap, baby wipes, nappy disposal bags and paper towels
- Ask parents to accompany children to the toilet and supervise hand washing
- Clean changing mat after each use
- Think about safe and healthy options when choosing snacks and drinks.

## Reminders

- Hold a regular fire drill
- Keep an up-to-date first-aid box
- Have a qualified first-aider at all sessions
- Check the safety of the room before all sessions
- Keep buggies secure and away from the entrance
- Maintain cleanliness and lock up cleaning equipment
  - Use stair-gates
  - Dispose of nappies with care
  - Buy toys with safety symbols
  - Clean and check toys regularly
  - Provide a safe area for babies
- Keep children in direct sight at all times
  - Be careful of hot drinks.

## Infectious illness



Condition	This disease is spread by:	Early Symptoms	Time between exposure and sickness	Exclusion from groups or pre-school
<b>Rashes and skin infections</b>				
Chicken Pox 	Coughing sneezing and contact with weeping blisters	Fever and spots with a blister on top of each stop	10-21 days after being exposed	1 week from appearance of rash, or until all blisters have dried
Hand, foot and mouth disease	Coughing, sneezing, and poor hand washing	Fever, flu-like symptoms—rash on soles and palms and in the mouth	3 – 5 days	Exclude until blisters have dried. If blisters able to be covered, and child feeling well, they will not need to be excluded
Head lice (nits)	Direct contact with infested person's hair	Itchy scalp, especially behind ears.	N/A	None, But setting should be informed. Treatment recommended to kill eggs and lice
Scabies	Contact with infected skin, bedding and clothing	Itchy rash	4-6 weeks (but if had scabies before it may develop within 1-4 days)	Exclude until the day after appropriate treatment
Impetigo (school sores)	Direct contact with infected sores	Blisters on the body which burst and turn into scabby sores	Variable	Until sores have dried up or 24 hrs after antibiotic treatment has started
<b>Diarrhoea &amp; Vomiting illnesses</b>				
Gastroenteritis, Salmonella, 	Undercooked food, contaminated water. Direct spread from an infected person or animal.	Stomach pain, fever, nausea, diarrhoea and/ or vomiting	6—72 hours	Until well and 48 hours after last episode of diarrhoea or vomiting Salmonella— discuss exclusion of cases and contacts with public health services
<b>Respiratory Infections</b>				
Influenza and flu like illness	Coughing and sneezing. Direct contact with infected person	Sudden onset of fever with cough, sore throat, muscular aches and a headache	1-4 days (average about 2 days)	Until well
Streptococcal sore throat 	Contact with secretions of a sore throat. (coughing, sneezing etc)	Headache, vomiting, sore throat.	1-3 days	Exclude until well and/or has received antibiotic treatment for at least 24 hours
<b>Other Infections</b>				
Conjunctivitis	Direct contact with discharge from the eyes or with items contaminated by the discharge	Irritation and redness of the eye. Sometimes there is a discharge	2-10 days (usually 3-4 days)	While there is discharge from the eyes
Pregnant women should seek from their maternity provider or G.P. 				
Vaccine—preventable 	Notifiable disease 			



For the sake of yourself and the group, if you or your child is unwell, it is better to stay home.



# Managing your money - Get organised & stay organised

- Set up a routine that works for you to maintain control of your money month to month.
- Compare your bank accounts at the end of each and every month with what you expect to have been paid in and out. If there are any differences make sure you understand why.

## Separate personal finances

- Keep any personal finances separate from the group's funds. Don't mix up your money or money from the group's money; at best this is confusing, at worst this could lead to fraud.
- Keep receipts for all expenses and record them. Make sure you have agreement that these items need to be bought by the group/committee.
- Open a bank account for your baby and toddler group.
- Using a formal bank account, rather than an individual's personal account, promotes independence and a separation between the group and individual.
- If possible (although it may not be with online banking) set-up your account so that you require at least two signatories when making payments, as this reduces the risk of mistakes being made or the chance of fraudulent activity.

## Opening a Bank Account

- 1 Identify a bank/Post Office/Credit Union that is convenient for the organisation
- 2 It is good practice that two people are required to sign all cheques
- 3 Identify two or preferably three (for cover) organisation members to be signatories for the bank account
- 4 Go to the bank and get an application form to open a new account
- 5 The particular bank may have special requirements but typically the following will be required:  
The two or three proposed signatories go to the bank with an ID and proof of address. Usually a passport or driving licence will suffice as proof of ID, and a utility bill (e.g. ESB or landline) showing the name and address of the person will be proof of address
- 6 Inform the bank that cheques are only to be accepted if signed by two signatories
- 7 Request a cheque book from the bank and decide who is most appropriate to hold it
- 8 Inform the bank where bank statements should be sent and inquire as to the frequency of the statements
- 9 The statements should be shown, by whoever receives them, to the other signatories
- 10 A record should be kept of all cheques written, noting the date, cheque number and amount, as well as the name of who is being paid and what for
- 11 Blank cheques should never be signed
- 12 If the account is expected to have significant volume of transactions, the option of internet banking should be explored, as well as the possibility of a group credit card.

## Annual accounts

- At the end of the year, you should prepare your annual accounts for your Baby & Toddler group. This is typically done by your treasurer as a simple record of all the income and expenses throughout the year. You will have an opening balance at the start of the year and a closing balance at the end of the year.
- Once you have prepared the accounts, you should ask someone independent (e.g. not the person who prepared them) to review the accounts. The person reviewing should have the financial knowledge and experience to do this properly.

## Transparency & communication

- Keep everyone up to date with the group's financial position.
- Try to keep your reports simple so others can understand them.
- Transparency is a great way to promote trust within your group and sharing your financial position is key to this, particularly if your members pay a fee and would like to see where their money is going!

A sample Finance Policy can be found on the USB memory stick.



## Sample Finance Policy

XXXX Baby and Toddler group will manage our finances in an honest and transparent way. We will do this by ensuring:

- All transactions are recorded.
- Weekly contributions are counted by two people and a record signed.  
Ideally cash should be lodged to the group's bank account every week.  
Where this is not practical; cash will be stored safely until a maximum of xxx (e.g. €50) has accumulated.  
At this point the money must be lodged to the bank account.
- All expenses are recorded, and receipts are kept safely.
- At the end of each month (or as agreed by your committee) the bank account is checked and corresponds with our records.  
If there are any differences make sure you understand what has happened and why.
- Any expenses over xx (example €20) are agreed with the committee before purchasing.  
If the group is organising an event, e.g. a Christmas party, a budget will be agreed before the event is organised.
- At the end of each year, an annual account will be prepared and circulated to all the committee members.  
Consider circulating it to all the parents and families who attend the group.



# Tips for planning a Baby & Toddler session

Put together a simple structure, along the lines of:

- 1 Welcome
- 2 Free play
- 3 Activity
- 4 Nursery Rhymes/Stories
- 5 Finish

Have an assigned person to open up the room and set up the space – give some thought to how chairs and play zones are arranged, as this will influence how your session runs.

## Start:

Someone to say “welcome to our group, today we will do... and welcome any new attendees”.

## Free play:

Usually involves children playing freely with some toys and resources. Some groups encourage parents to spend time interacting with their child/ren while other groups use this time for the adults to have a tea/coffee and spend time interacting with the other adults, while each adult continues to supervise their child/ren.

## Activity:

- Have a monthly plan for activities:
- Use a suggestion box for ideas
  - Different parents to lead activities each week
  - Do a ‘tidy up’ game or song when finished
  - Be clear about what you want parents to do or to lead.

## Nursery rhymes/stories:

Encourage different parents to read or tell a story each week. It's better to sing nursery rhymes yourselves rather than follow a CD as you can slow down the speed to of the rhyme to suit the children. Finish with the same song each week so the children recognise that its the end of the session.

# Parents or children groups tips

Baby and Toddler group provide a social space for parents and children to make friends and spend time with parents and children. Some group feel their priority is to provide a social space for their parents to chat with other adults while other group place a lot of emphasis on the children playing and learning or it can be combination of both.

Thinking about the room layout will help support the type of group you wish to create, putting chairs around a table will tend to put the focus on the cup of tea with adult spending most of their time chatting with small babies on their knee and older children playing in the room.

Setting up chairs or cushions in a circle in the centre of the room will tend to put the emphasis on the parent and child sitting together, maybe reciting rhymes and listening to stories.

Setting the room up into different play areas will encourage the children to move between areas getting different play experiences. If adult chairs are situated near the art and craft table, parents and children will be more likely to work together on the activity.

Where and how you place chairs will help dictate where parents are when children are playing.

As group think about the type of group you want to be and try a few different room set ups to see how they impact the group dynamic.

A combination that provides for both the children's and the parent needs probably works best for all.



You will find your rhythm as a group - it just takes a little time and maybe some trial and error!

# Tips for making your group Inclusive

Be aware of your language, make it as inclusive as possible.



- 1 **Meeting and greeting parents and children** is very important and helps everyone to feel welcome. This can be an assigned role
- 2 **Learning parents and children names** is important and gives a great sense of belonging
- 3 Find a **variety ways of communicating** with group members. Examples include; text messages, phone calls, Whats App group, Facebook page or other social media platforms. These are useful for sharing ideas, supporting communication and providing information to members
- 4 When **promoting your group** if you use posters, leaflets, Facebook or flyers use a range of images for example dads, grandparents, carers with disabilities and families from a range of backgrounds. Make it clear that parent, au pairs, childminders or grandparents are welcome to attend
- 5 It's the role of the facilitator to **challenge stereotypes** and to address children's curious questions
- 6 Have a look at your **resources to ensure that they are gender neutral**. For examples, books that show men in caring roles, have multicultural girl and boy dolls, a diverse selection of play props and dress up resources
- 7 If your group has books try to have a variety such as books with no words, picture books and a variety of languages
- 8 When speaking to the group be careful to **include children's fathers** even if they are not attending. If you are organising special events or outings, make sure partners are included in the invitations
- 9 **Peer mentoring**. If you have Dads in the group for example encourage them to bring along other Dads

- 10 **Ask new parents** about their child's favourite game or activity
- 11 If you want to **create social space for parents** chairs around a table will encourage them to sit and chat together
- 12 **Parents will sit with others they know** especially if they have a common language; make an effort to purposely integrate everyone, so every one in the group gets to know others
- 13 Once in a while play a game of Musical chairs for parents as a way to meet new people
- 14 Children aged 2 – 3 years will usually initiate play with other children themselves and are very apt at making new friends. Encourage and actively support this
- 15 **Introducing group games** builds a sense of belonging and will get parents to move around. A simple example is to use a parachute when singing nursery rhymes sometimes
- 16 **Visual cues or prompts** can make it easier for parent and children to get to know the rhymes you usually sing e.g. a picture of a spider can be used to indicate 'Incy Wincy spider'

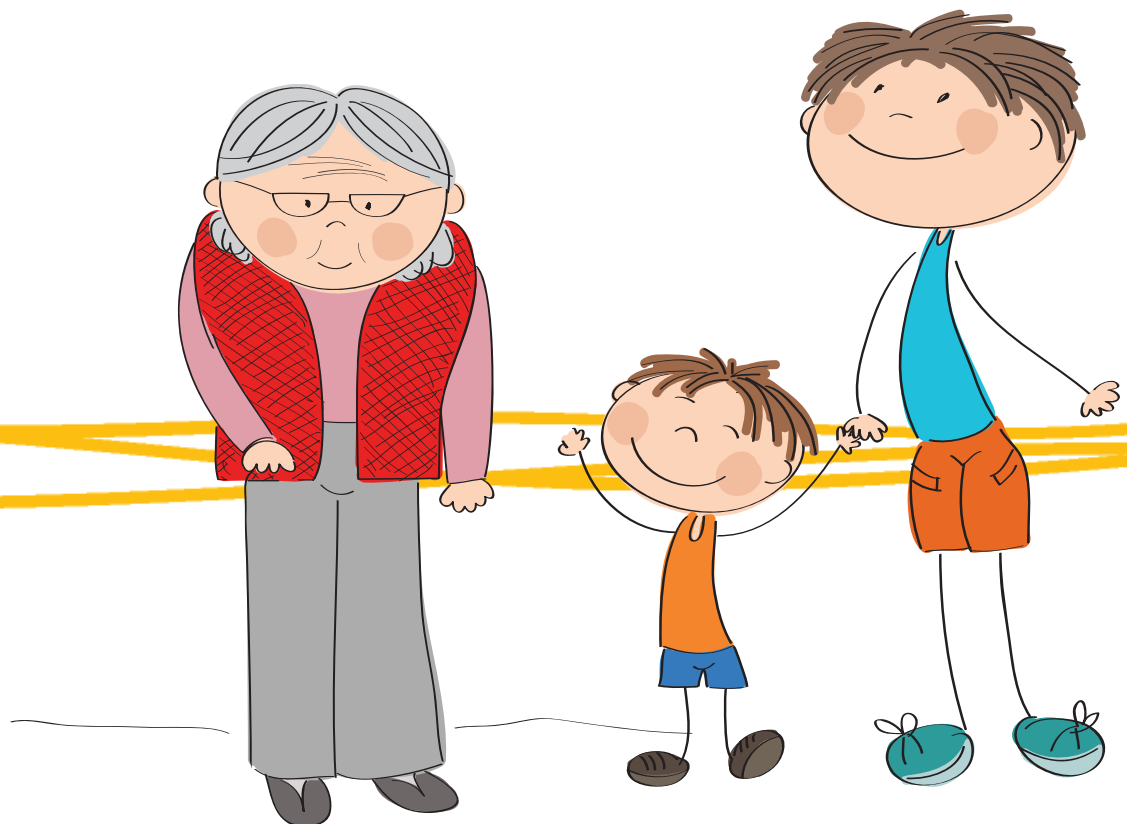

# Summary

## Tips for running a happy & safe group

Consider developing a Group Code or agreement to ensure everyone knows what they are agreeing to when they join the group

There may be roles within the group such as an organiser, a welcomer and a play planner etc. Make sure you share the work load.

Everyone helps with clean up. Start as you mean to go on, so jobs are equally shared

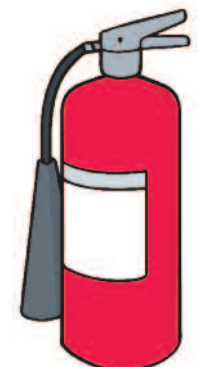

# Play

Supporting children's natural language



# Play - Some Pointers

1

Babies and toddlers play. Parents and caring adults tuning into children's play and actions provide the perfect opportunity to support babies and young children's learning. In your group, ensure parents and children get plenty of opportunities to play together.

2

Babies and toddlers use their senses to explore the world around them. In your group, providing a wide variety of sensory learning experiences help children make sense of the world around them.

3

Singing nursery rhymes, reading and telling stories helps children learn language in a fun way. Each week include a regular rhyme and story time.



For play ideas and Rhyme time fun check [www.loveparenting.ie](http://www.loveparenting.ie)

LOVEPARENTING.IE

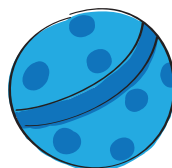

# Some benefits of play

- Play produces well-wired minds
- Play is critical to brain development
- Children gain all the skills they needs physically, socially, cognitively, emotionally and creatively through play.

When children play they are:



# Play



Most play activities require little financial outlay, and all are good at developing a child's skills and self-confidence. No matter what type of play is taking place, it will be the close contact and conversation between parent/carer and the child, that will form a sound basis for learning.

The parents and adults who care for them help the child to make sense of this exciting new world, whether it is by tuning into the child's actions and putting new words on them, e.g. the baby points at the light and the adult says 'oh you see the light', or welcoming the cup of tea the child has prepared for them with their new tea set. These types of quality interactions support children's understanding of the world and help their language development.

Imagination is so important when presenting and suggesting play activities, as it is one of the best ways of encouraging a child to use theirs. All children play; however, the quality of this play is greatly influenced by the adults around them.

**Toys are useful, but they do not have to be bought toys.**

For example,

- Old clothes can be used for dressing up
- Boxes can be used for crawling in and out of, and make great forts

Parents/carers can provide materials and encouragement and open the door to new activities, learning and fun.

## Creating and maintaining a rich play/learning environment

Children from birth through to eight years of age have developmental needs and capacities that differ from those at any other time in their lives. Play starts from birth, but obviously changes as each new stage of development is reached. Each child develops at his or her own pace. With stimulation and encouragement, all children develop and learn.

It is by understanding this that the parent/carer can create an environment suitable to the age and stage of development of their child/ren. Whatever the age or developmental stage of the baby or child, if they are totally involved in playing they are totally involved in learning.

**Parents/carers are instrumental in enabling the child/ren in their care to learn because they provide the care, security, stimulation and chat that makes play meaningful.**

Sometimes when we think of creating a safe, happy and friendly play environment for toddlers and children, we do not always appreciate the needs of the developing 6-9 month-old infants.

**Would it surprise you to learn that a baby's brain doubles its actual weight in the first two years of life?**

**Or that the fast-growing brain actively seeks stimulation through a variety of play activities? **Your** interaction and play with your baby makes a difference.**



# Baby

## Useful tips and bits to consider

Babies can't be expected to amuse themselves. They need to be held, talked to, played with, and need a variety of different viewing points to engage their attention and avoid being bored.

Toys for this age group don't have to be elaborate or expensive. Babies love watching other children play together and this can provide endless opportunities for enjoyment. You are your baby's best toy! They love playing with you.

Toys should be hard-wearing and reliable. Toys to push, pull, ride on, stack, fit together, build with, and hammer will get lots of use!

## You might consider:

Providing hard-back books, cloth books and waterproof books

Having small toys that can be held in the baby's hand. Babies are curious and enjoy looking at and turning over hand-sized objects

Musical toys. Babies just love the sound of music

An activity mat/blanket that has a selection of different colours and textures



**Remember:** When selecting toys/equipment, remember that babies and toddlers learn by putting things in their mouth, so and these toys need to be washable.

# Toddler

## Useful tips and bits to consider

Toddlers are constantly on the go. Toys, nursery rhymes, songs and stories will be stimulating and engaging. Their imagination is developing, so “pretend” play and dressing up is great fun.

**Remember:** That all babies and toddlers love repetition and will play the same games again and again... and again!

### Toddlers enjoy a variety of activities such as:

- Moving toys
- All types of blocks, e.g. large Lego or Duplo, wooden blocks
- Junk box-selection of empty boxes, egg cartons, etc.
- Craft materials
- Play dough and messy play
- Ride-on toys
- Large crayons with large sheets of paper
- Books
- Dressing-up box
- Toy farm/zoo animals
- Garages, trucks, cars, tractors and lorries
- Pop up tents, tunnels and large cardboard boxes
- Dolls and prams
- Playhouses and kitchens
- Balls of different sizes
- Cycles, tractors, small slides
- Materials for junk art

**Consider your available storage space because whatever you choose to use will need to be packed away.**

**Remember:** Most toddlers can understand much more than they can say, so chatting to them and explaining things is really important.



## Play dough & messy play

- Is fun for children to make - and relatively inexpensive!
- Promotes understanding of the concepts of size, weight and volume
- Encourages learning through touch
- Presents opportunities for children to learn about textures, colours and shades
- Promotes language development e.g. fat, thin, long, round etc.



### Simple play dough recipe

#### Ingredients

- 2 cups plain flour
- 1/4 cup salt
- 2 table spoons oil
- 1 cup cold water
- A few drops of liquid food colouring

#### Method

Combine plain flour and salt.  
Add water, food colouring and oil.  
Mix until ingredients are combined.  
Knead well.  
If consistency is too wet add a little plain flour, if too dry add additional water.

#### Other options

Consider adding one of these to get a variety of textures:  
Cake sprinkles (particularly suitable if you have child/ren who like to put the dough in their mouths)  
Glitter, Sand, Coconut and Rice.



### DIY Gloop

A mixing dish and some aprons

#### Ingredients

- 2 cups of corn flour
- 1 cup of water
- A few drops of food colouring (optional)







## Paint

- Is creative and expressive
- Promotes hand to eye co-ordination/ pre-writing skills
- Allows children to practise gripping
- Develops awareness of colour and texture.



## Water play

- Children love it
- Free
- Versatile
- Children learn how to pour
- Children learn about volume and weight
- Promotes language development, e.g. full, empty, sink, float, pour etc.
- Is fun and therapeutic.



## Toy play

- Develops concentration, e.g. construction toys
- Stimulates imagination, e.g. farms, zoos, garages, school
- Can form a basis for great conversation.



## Physical play

- Releases bottled up energy and high spirits
- Aids bone and muscle development by, for example, climbing, crawling, running, dancing and balancing
- Teaches children about their physical relationship to the world by having space to move in and things to crawl through and climb over.



## Sand play

- Is versatile
- When dry, children may pour, fill, shake and sieve
- When wet- children may mould, shape and build
- Soothing activity
- Promotes basic understanding of mathematical and scientific concepts of weight, volume, cause and effect.



## Junk play

- Helps hand to eye co-ordination through use of safety scissors and brushes (Remember left handed scissors are available for children)
- Aids concentration
- Develops the child's ability to make decisions
- Great "rainy day" activity
- Encourages resourceful ways of using materials and promotes recycling
- Promotes visual awareness.



## Imaginative play/role play

- Children enjoy dressing up, and playing "pretend"
- Opportunity to relive happy experiences and come to terms with unhappy ones
- Learn about the world around them
- Develops language
- Builds self-confidence.



## Songs, rhymes & story-telling

- Enjoyed by children of all ages
- Promotes language development
- Encourages listening and concentration skills
- Develops the processes of thought, reasoning and imagination
- Reinforces the concepts of time, e.g. past, present and future.





## Doing things together builds brains

- For example, cleaning, tidying, washing, gardening
- Builds close relationship between child and parent/carer
- Children love to take part in what adults do
- Builds self-confidence and independence
- Allows child to learn new skills
- Encourages understanding about real work.



## Outdoor Play

We sometimes forget how important outdoor play is. Fresh air is important, and children get vitamin D from sunlight. Children should be given the opportunity to explore and experience outdoor play at all times of the year.

- It's free
- It's fun and children love it
- It's healthy for all age groups
- It promotes awareness of nature and the changing seasons
- It's a versatile environment in which all of the other types of play can be carried out.

# Inexpensive play resources Children LOVE



## Simple Shape sorters

Commercial shape sorters can be difficult for young children to complete.

By making your own using jar lids and a small box you provide the opportunity for the child/ren to experience success.

As children get older you can increase the difficulty by reducing the size of the jar lids and making the size of the slot smaller.

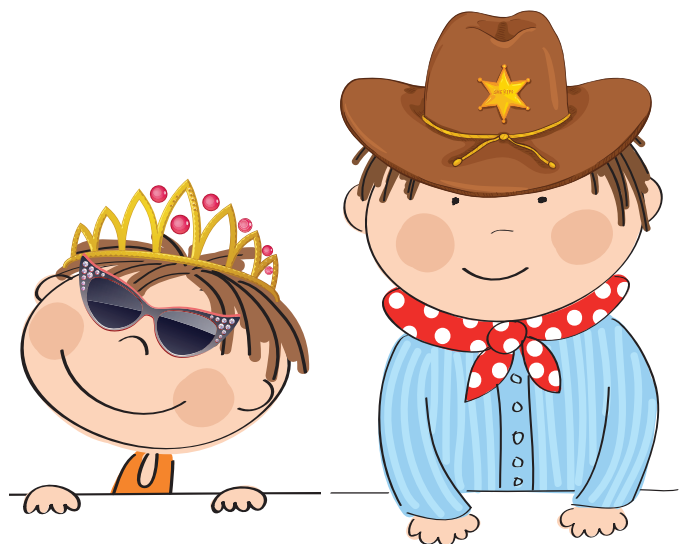



## Dress up ideas

Old material, clothes and accessories you have at home provide unlimited possibilities for dress up. Commercial dress-up clothing available in the shops tends to be expensive and limits the child's imagination and creativity.

In a hat, necklace and high heel shoes, a child can be anyone they know and love; a TV presenter, a fashion model or a princess. In a shop bought princess dress, most children will only think of themselves as a princess.



## Exploring Citrus fruits

Exploring different fruits: Children learn by doing — this gives children the opportunity to explore the world around them. Offering the opportunity to see, feel, taste and smell different fruits can be an enriching experience for young children.

Examples for citrus fruits: Lemon, lime, red & yellow grapefruit, tangerine, orange and satsuma.



## Making Play Houses

Any combination of a table, chair, a sheet, blanket or a cardboard box can become a house, a home, a den, a hide-away or a magical castle. The possibilities are limitless. It just takes imagination.

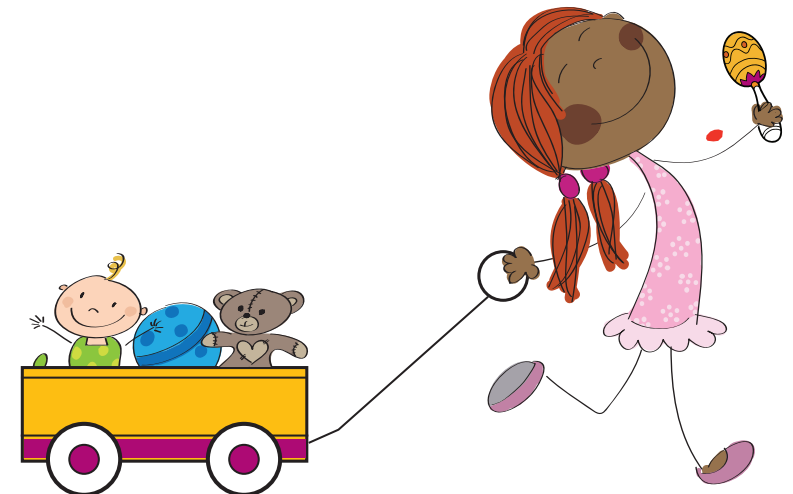

# Know your boundaries

Protecting the 'you' in our  
Baby and Toddler group

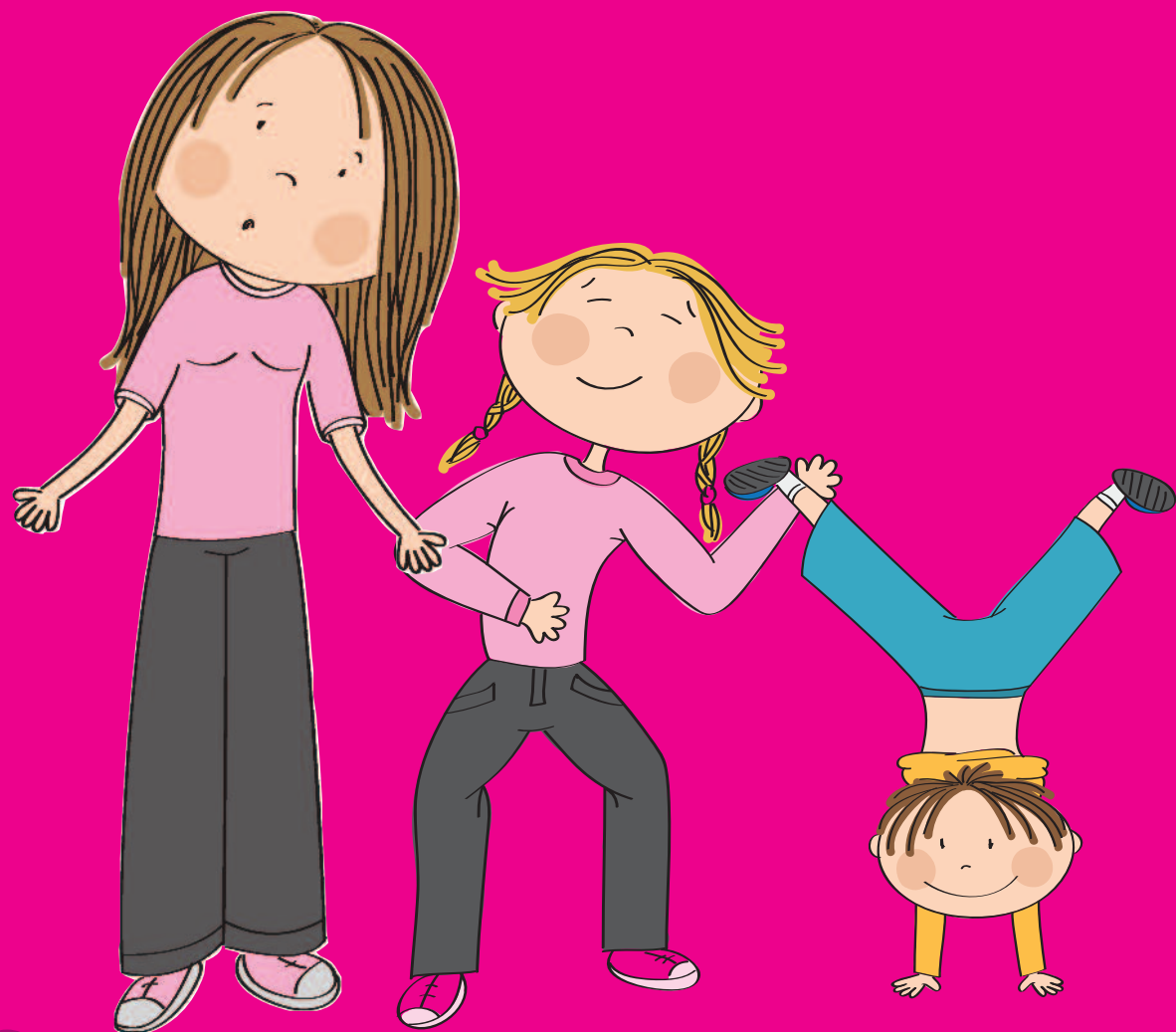

## Know your boundaries

The absolute strength of a Baby & Toddler Group lies in the peer relationships that it creates. Parents advising and supporting each other is a natural support that is priceless. That same informality can sometimes lead to boundaries that are over-stepped, so you need to make sure that as a facilitator/organiser, you are very clear on your own boundaries.

There may be times, for example, where information is disclosed to you by a group member. This could be anything from a parent's worries about their child's development, finances etc. or you may hear about very sensitive issues such as domestic abuse. The thing that you have to bear in mind is that such information is bigger than you. It is far more than you can take on in your role within the Baby & Toddler Group.

Baby & Toddler Groups really help parents/carers to grow more confident in their parenting role. While a book or a website offer advice on say, teething, it is the tips from other parents that often carry more weight. Parents of twins can meet parents of other multiples and hear about dividing attention, love and patience two ways at once! **The point is, Baby & Toddler Groups support parenting and enable relationships to flourish.**

Parents who have been attending your group for a while, and who seem comfortable when roles or duties are given to them, may be ready to play more of an active role in the organisation of the group. Don't be afraid to let that happen. Parents who feel that they have benefitted from all of your work may want to offer other/newer parents that same help. They may be happy to take on more responsibilities or even to co-facilitate with you.

**Support them to 'pay it forward' because, as we all know, it takes a village to raise a child. You should be content in the knowledge that your group had created a happy and safe village!**

## Don't take on responsibilities that are not yours

If a member of the group needs further support, you are not responsible for providing it, however, you can help by pointing them in the right direction.

Help is available from organisations listed in the Parenting Limerick brochure (Section 6 Additional Resources).



Help is available from organisations listed in the Parenting Limerick Boucher (Section 6 Additional Resources).



## Child welfare or child protection concern

All adults have a responsibility to ensure children are safe and well protected.

If, as a member of the public, you have concerns about a child or if you are worried about a child's safety or welfare, but are not sure what to do, you should contact your local Tusla Children and Family Services.

If you think a child is in immediate danger and you cannot contact the Tusla Children and Family Services, you should contact the Gardaí at any Garda station.

**Under The Protection of Persons Reporting Child Abuse Act 1998, so long as you report what you believe to be true and it is done in good faith you cannot be sued.**

[www.tusla.ie/services/child-protection-welfare/contact-a-social-worker](http://www.tusla.ie/services/child-protection-welfare/contact-a-social-worker)

## Limerick Duty Social Work Teams

Tusla Child and Family Agency, Roxtown Health Centre, Child Protection and Welfare, Old Clare St, Limerick

Phone 061 483098

Office Hours 9am to 5pm

Any query or concern in relation to children out of hours should be reported immediately to An Garda Síochána.

[www.tusla.ie/services/child-protection-welfare/contact-a-social-worker](http://www.tusla.ie/services/child-protection-welfare/contact-a-social-worker)

## Children First Guidelines

All children attending this group have a right to be safe and protected.

Follow Children First Guidelines and ensure that at least two of your committee members have completed the children first e-learning training.

If you have any concerns about a child's welfare, make contact with Tusla Duty Social Worker for guidance and support.

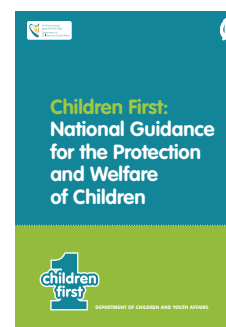

Standard Notification form is contained in section 4



TUSLA  
An Ghníomhaireacht um  
Leanaí agus an Teaghlaigh  
Child and Family Agency

[www.tusla.ie](http://www.tusla.ie)

## Child Safety Statement

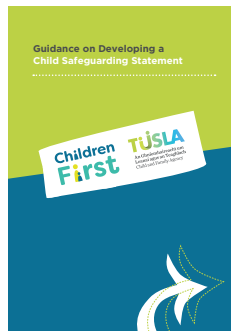

**Paid employee:** All groups being facilitated by a paid employee need to have a Child Safety Statement. The support organisation will support the facilitator to develop this statement for the group.

For further information on developing a Child Safety Statement:

[www.tusla.ie/uploads/content/4214-TUSLA\\_Guidance\\_on\\_Developing\\_a\\_CSS\\_v3.pdf](http://www.tusla.ie/uploads/content/4214-TUSLA_Guidance_on_Developing_a_CSS_v3.pdf)

**Voluntary:** A voluntarily run and managed group isn't obliged to develop a Child Safety Statement.

Any query or concern in relation to children out of hours should be reported immediately to An Garda Síochána.

[www.tusla.ie/services/child-protection-welfare/contact-a-social-worker](http://www.tusla.ie/services/child-protection-welfare/contact-a-social-worker)

If there is a child protection disclosure or concern by an adult during a session, the facilitator/group leader should complete the following procedure:

- Ask the adult if they would like to talk about the issue/concern further on a one to one basis (a group setting is not a suitable place for a disclosure)
- Explain concerns that this is a child protection or child welfare issue and explain the child protection procedures in place.

If you have a concern about a child, please follow the steps below:

## Designated Child Protection Officer

### Child protection and welfare procedure

- Contact the Designated Child Protection Officer for your organisation who will contact the Child and Family Support Agency Social Work Department Child Protection Service to report the concern, in line with the Children's First Guidelines for the Protection and Welfare of Children.

In an out of hours situation, contact will be made with the Garda Síochána if the matter requires an urgent response.

- If your group doesn't have a Designated Child Protection Officer, anyone can contact the Child and Family Support Agency Social Work Department Child Protection Service to report the concern, ask advice or seek guidance.
- Reports should be made directly to the CFSA in writing using the Standard Notification Form (SRF) to Tusla Duty Social Work Service.

More information and training on Children First is available in the form of an e-learning programme.

[www.tusla.ie/children-first/children-first-e-learning-programme/](http://www.tusla.ie/children-first/children-first-e-learning-programme/)

## Children First E-Learning Programme

Tusla has worked with the DCYA (Department of Children and Youth Affairs) and HSE to develop a universal e-learning training programme called 'Introduction to Children First'. The programme has been written to support people of all backgrounds and experience in recognising concerns about children and reporting such concerns if they arise.

The programme is based on **Children First: National Guidance for the Protection and Welfare of Children and the Children First Act 2015**.

The programme takes approximately 1.5 hours to complete but it can be done in a number of sittings. The programme will allow you to log back in and resume where you left off.

### It covers topics including:

- Recognising and reporting child abuse;
- The role of mandated persons;
- The responsibilities of organisations working with children to safeguard children;
- The role of designated liaison persons.

You will need to create an account using an email address to log in and complete the programme. This allows you to complete the training gradually over time.

When you have completed the programme, you will receive a certificate of completion directly to your email address.

[www.tusla.ie/children-first/children-first-e-learning-programme/](http://www.tusla.ie/children-first/children-first-e-learning-programme/)



# Policies & Procedures

How to ensure best practice

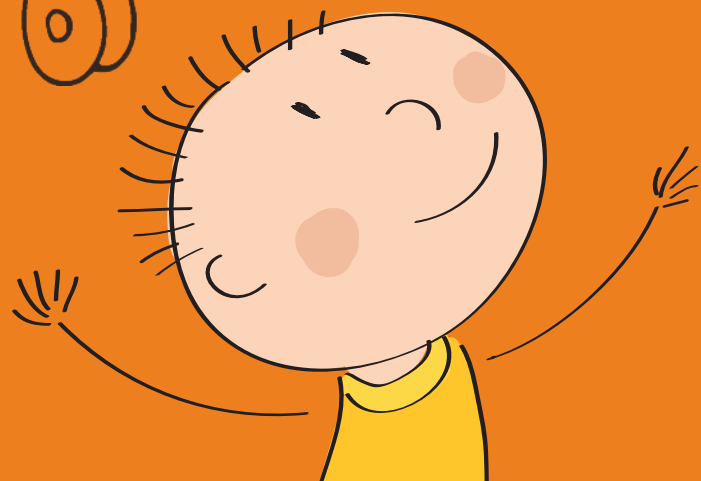

# Policies

Baby & Toddler groups often assume that there is little need for policies within the group. Policies are important as they help explain what a group does and how it does it.

When writing a policy you have a lot of discretion about what you say about your group and how you do things. They can provide protection for everyone as well as setting out good practice and transparency. When policies are written down it is less likely there will be misunderstanding within the group.

As a good practice measure it may be appropriate to develop some written policies for your Baby & Toddler Group.

To help you write your policies we have provided a USB memory stick where you will find editable version of these suggest documents.

## Some suggestions are as follows:

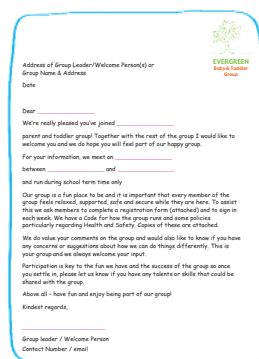

A **WELCOME LETTER** giving:

- the purpose of the group
- opening hours & fees (if applicable)
- information about the waiting list and
- a registration form.

Sample letter on page 60

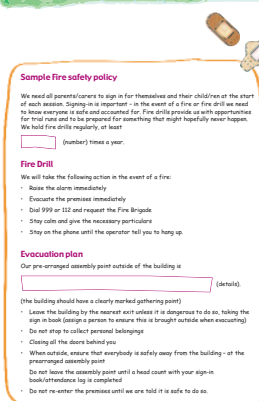

**HEALTH & SAFETY PLAN** may include:

- Infectious diseases
- Risk assessment
- Fire Drill Procedure
- an outing policy if your group organises outings for your parents.

Sample plan on page 74

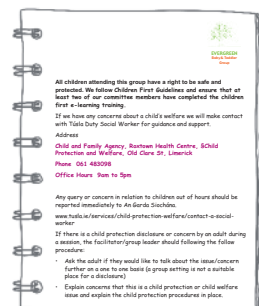

A **CHILD PROTECTION POLICY** lets others know:

- How you will ensure children are safe within the group and
- how you will manage a disclosure if a child or an adult shares an experience.

Sample policy on page 63

# The following pages contain SAMPLE polices. You can edit or use them according to the particular needs of your group.

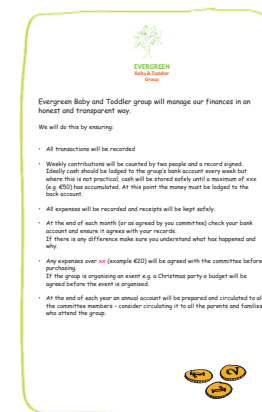
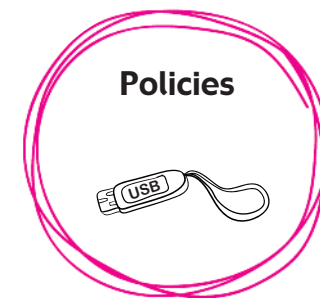

Most groups collect a donation/fee each week and apply for annual funding to support the running of the group, a **FINANCE POLICY** stating how money is looked after allows for transparency within the group.

Sample policy on page 73

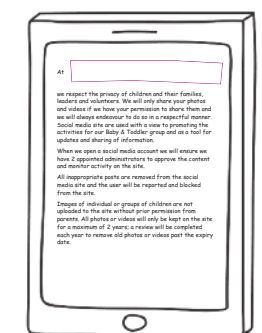

If your group has a Facebook page maybe your group should have a **SOCIAL MEDIA AND A PHOTOGRAPHIC POLICY**, so parents know and understand how pictures taken in the group maybe shared.

Sample policy on page 68

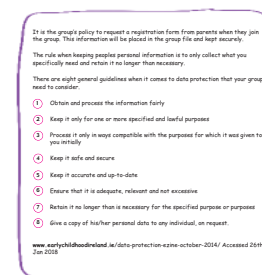

Now a days if you are collecting personal information about adults and children you will need to have a **DATA POLICY** simply saying why your are holding this information and what you will do with it and how you will share it or not.

Sample policy on page 67



# Welcome Letter



Address of Group Leader/Welcome Person(s) or Group

Name & Address

Date

Dear \_\_\_\_\_

We're really pleased you've joined \_\_\_\_\_

parent and toddler group! Together with the rest of the group I would like to welcome you and we do hope you will feel part of our happy group.

For your information, we meet on \_\_\_\_\_

between \_\_\_\_\_ and \_\_\_\_\_

and run during school term time only

Our group is a fun place to be and it is important that every member of the group feels relaxed, supported, safe and secure while they are here. To assist this we ask members to complete a registration form (attached) and to sign in each week. We have a Code for how the group runs and some policies particularly regarding Health and Safety. Copies of these are attached.

We do value your comments on the group and would also like to know if you have any concerns or suggestions about how we can do things differently. This is your group and we always welcome your input.

Participation is key to the fun we have and the success of the group so once you settle in, please let us know if you have any talents or skills that could be shared with the group.

Above all - have fun and enjoy being part of our group!

Kindest regards,

\_\_\_\_\_  
Group leader / Welcome Person  
Contact Number / email

## Examples of information to include:

- Our Facebook is.....
- We have a closed What's App group.....
- Group specific information
- Where to store buggies, park cars ....
- Please take home dirty nappies...
- Put group code on the back of this page

# Group Code



Our group is open and positive to difference and diversity and strives to include all. We will:

- Have fun
- Take time to play with our child/ren
- Make an effort to be open and friendly with others
- Be responsible for our own children and keep an eye on your child and intervene to prevent any harm to your child or anyone else
- Be responsible for our own child's behaviour. If a child is "acting out" and a parent/carer is unaware, feel free to give a gentle nudge and draw the parent/carer's attention to their child so that she or he may deal with it positively
- Get involved in planning and leading activities
- Help with clean-up after each activity and involve the children
- Always remember that our group is most definitely not a crèche or drop-off service
- We would ask that school age children would not be brought to the session on days off school or when the child is sick (for obvious safety reasons)
- Be aware that sometimes, children may present with special need or mild behavioural issues. Our ethos is to be inclusive and supportive.

## Remember:

If you or your child is unwell, you are both better off home.

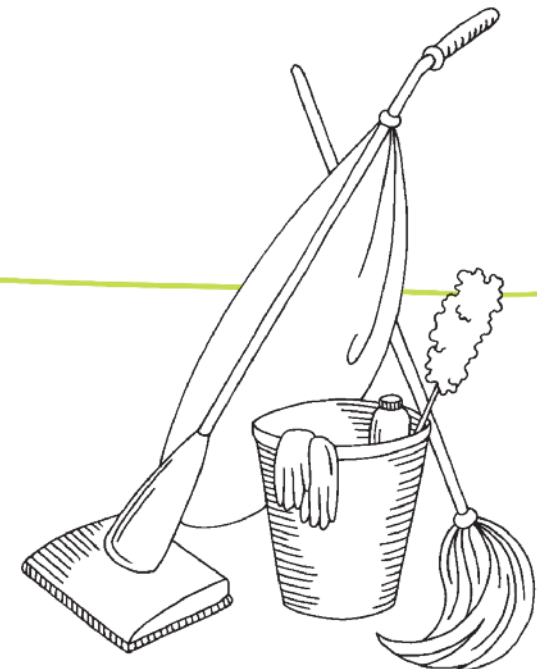

## Mission Statement



The Evergreen Baby & Toddler Group aim is to provide a safe and stimulating environment for all children to grow and develop holistically.

To provide parents with the opportunity to meet and learn from other parents in a relaxed non-threatening environment.

## Aims & Objectives



Clearly defined Aims and Objectives will help the group to remain focused on the work they have undertaken.

1. To provide a safe environment in which children are encouraged to play together.
2. To promote the active participation of parents in the activities of the group.
3. To highlight the importance of play in children's development.
4. To ensure that the group is accessible to all children & parents in the community.

## Child Protection Policy for a Baby & Toddler Group

All children attending this group have a right to be safe and protected. We follow Children First Guidelines and ensure that at least two of our committee members have completed the children first e-learning training.

If we have any concerns about a child's welfare we will make contact with Tusla Duty Social Worker for guidance and support.

Address  
**Child and Family Agency, Roxtown Health Centre, Child Protection and Welfare, Old Clare St, Limerick**  
**Phone 061 483098**  
**Office Hours 9am to 5pm**

Any query or concern in relation to children out of hours should be reported immediately to An Garda Síochána.

[www.tusla.ie/services/child-protection-welfare/contact-a-social-worker](http://www.tusla.ie/services/child-protection-welfare/contact-a-social-worker)

If there is a child protection disclosure or concern by an adult during a session, the facilitator/group leader should following the follow procedure:

- Ask the adult if they would like to talk about the issue/concern further on a one to one basis (a group setting is not a suitable place for a disclosure)
- Explain concerns that this is a child protection or child welfare issue and explain the child protection procedures in place.

**Child protection and welfare procedure**

- In an out of hours situation, contact will be made with the Garda Síochána if the matter requires an urgent response.
- If your group doesn't have a Designated Child Protection Officer, anyone can contact the Child and Family Support Agency Social Work Department Child Protection Service to report the concern, ask advice or seek guidance.
- Reports should be made directly to the CFSA in writing using the Standard Notification Form (SRF) to Tusla Duty Social Work Service.

# Baby & Toddler Registration Form

Name of Parent/Carer:

Name of child:  Date of Birth:

Name of child:  Date of Birth:

Address:

Telephone Number:

In the unlikely event that you become ill or in an emergency whom should we contact?

Name & tel. no.:

Do you or your child/ren have any allergies/illnesses/conditions e.g. egg allergy, that the group might need to be aware of? If so, please provide relevant details:

Have you been provided with a copy of Our Code and our welcome letter?

Are you happy to be bound by Our Code?

Do you have any skills or talents that you would be happy to share with the group?

## Data Protection Declaration

Please note that the information given will not be used for any other purpose other than for the purpose of contacting you. This form will be stored securely at all times.

# Photo Release Consent



From time to time in our group we take photos or short videos of activities or outings and we would like your permission to use photos/videos for the purpose of sharing information about (name of group).

This may include the use of photo/video on displays, flyers, posters or social media etc.

\_\_\_\_\_ has a responsibility to ensure that images will be used in a positive and professional manner. The images/videos cannot be used by third parties or for other purposes without your consent.

If you consent to the use of photos that may include your child, please sign here and tick the forums we can use your photos/videos on:

- Internal displays & usage
- Flyers, posters or printed materials - promotional materials
- Social media, such as our Facebook page, What's App etc.
- Websites such as Loveparenting.ie ..... Etc.

Signature Date \_\_\_\_\_

Name (Please Print) \_\_\_\_\_

Thank you for your help.

Please put the photo consent at the back of this page.

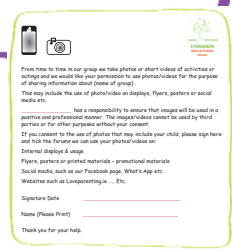

# Child Consent

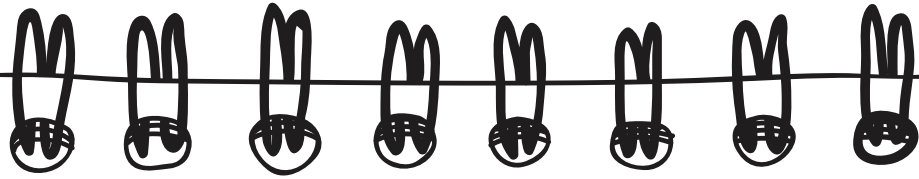

We would like to take photos/videos of you, we will use these to tell others about our group.

YES  NO

I am happy for you to take photos/videos of me.

Child's Name (Please Print) \_\_\_\_\_ Date \_\_\_\_\_

The taking and use of photographs in the group needs to comply with data protection law.

Photographs taken by parents for personal use only is exempt from the Data Protection Act.

Written permission from the parent or carer is required for all other photographs to say they are happy for the photographs to be used.

Set out in the agreement letter where and when the photographs will be used, and for what purpose. Be very clear.

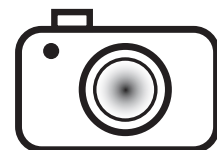

# Data Protection Policy – GDPR

It is the group's policy to request a registration form from parents when they join the group. This information will be placed in the group file and kept securely.

The rule when keeping peoples personal information is to only collect what you specifically need and retain it no longer than necessary.

There are eight general guidelines when it comes to data protection that your groups need to consider.

- 1 Obtain and process the information fairly
- 2 Keep it only for one or more specified and lawful purposes
- 3 Process it only in ways compatible with the purposes for which it was given to you initially
- 4 Keep it safe and secure
- 5 Keep it accurate and up-to-date
- 6 Ensure that it is adequate, relevant and not excessive
- 7 Retain it no longer than is necessary for the specified purpose or purposes
- 8 Give a copy of his/her personal data to any individual, on request.

[www.earlychildhoodireland.ie/data-protection-ezine-october-2014/](http://www.earlychildhoodireland.ie/data-protection-ezine-october-2014/) Accessed 26th Jan 2018

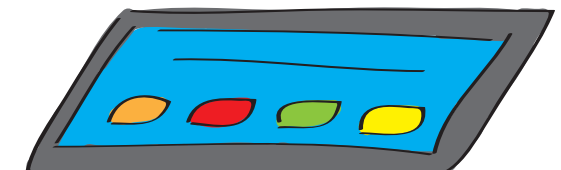

# Social Media Policy

At

we respect the privacy of children and their families, leaders and volunteers. We will only share your photos and videos if we have your permission to share them and we will always endeavour to do so in a respectful manner.

Social media site are used with a view to promoting the activities for our Baby & Toddler group and as a tool for updates and sharing of information.

When we open a social media account we will ensure we have 2 appointed administrators to approve the content and monitor activity on the site.

All inappropriate posts are removed from the social media site and the user will be reported and blocked from the site.

Images of individual or groups of children are not uploaded to the site without prior permission from parents. All photos or videos will only be kept on the site for a maximum of 2 years; a review will be completed each year to remove old photos or videos past the expiry date.

# Sample Weekly Attendance Record

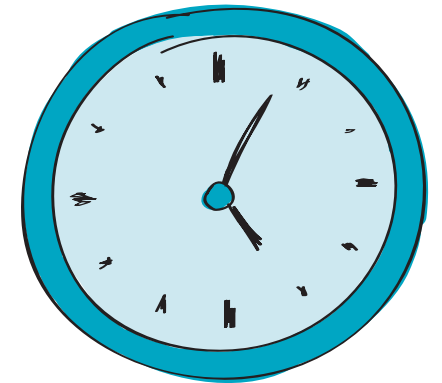

Date:

Parent/Carer's Signature	Time In	Time Out

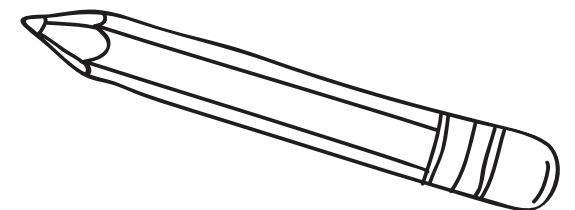

# Monthly Plan

Date

	Jobs (example)	Name	Comments
Key holder			
Shopper			
Finance			
Safety			
Welcomer			
Play Planner			

## The key holder

opens and closes the building

## The shopper

buys snacks and resources as required

## The finance person

looks after the money

counts the fees after the session (always get a second person to sign the record of the contributions)

makes sure the shopper has enough money to buy the snacks for next week collects and receipts

## The safety person

checks the room each week  
(see the Sample Risk Assessment Checklist)



## The welcomer

greet parents and children on arrival, introduces new members and ensures everyone signs in

## The play planner

makes sure a variety of activities are set up and facilitates the smooth running of the session.

# Waiting List Form

**EVERGREEN**  
Baby & Toddler  
Group

Parent's Name	Child's name	Child's year of birth	Contact telephone

# Accounts Form

Opening Balance in Account: €  Date:

## INCOME

Members contributions €

Fundraising €

Grants e.g. Childcare Committee €

Other €

**TOTAL** €

## EXPENDITURE

Rent €

Heating €

Electricity €

Insurance €

Refreshments €

Outings €

Christmas Parties €

Toys €

Equipment €

First Aid Kit Replacement Products €

Other €

**TOTAL** €

Closing Balance in Account: €

Signed Treasurer:

Date:

# Finance Policy



Evergreen Baby and Toddler group will manage our finances in an honest and transparent way.

We will do this by ensuring:

- All transactions will be recorded
- Weekly contributions will be counted by two people and a record signed. Ideally cash should be lodged to the group's bank account every week but where this is not practical; cash will be stored safely until a maximum of xxx (e.g. €50) has accumulated. At this point the money must be lodged to the bank account.
- All expenses will be recorded and receipts will be kept safely.
- At the end of each month (or as agreed by you committee) check your bank account and ensure it agrees with your records. If there is any difference make sure you understand what has happened and why.
- Any expenses over xx (example €20) will be agreed with the committee before purchasing. If the group is organising an event e.g. a Christmas party a budget will be agreed before the event is organised.
- At the end of each year an annual account will be prepared and circulated to all the committee members - consider circulating it to all the parents and families who attend the group.

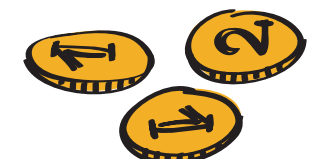

# Health & Safety Plan

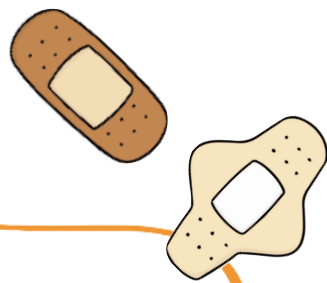

## Sample Fire safety policy

We need all parents/carers to sign in for themselves and their child/ren at the start of each session. Signing-in is important - in the event of a fire or fire drill we need to know everyone is safe and accounted for. Fire drills provide us with opportunities for trial runs and to be prepared for something that might hopefully never happen. We hold fire drills regularly, at least

(number) times a year.

## Fire Drill

We will take the following action in the event of a fire:

- Raise the alarm immediately
- Evacuate the premises immediately
- Dial 999 or 112 and request the Fire Brigade
- Stay calm and give the necessary particulars
- Stay on the phone until the operator tell you to hang up.

## Evacuation plan

Our pre-arranged assembly point outside of the building is

(details).

(the building should have a clearly marked gathering point)

- Leave the building by the nearest exit unless it is dangerous to do so, taking the sign in book (assign a person to ensure this is brought outside when evacuating)
  - Do not stop to collect personal belongings
  - Closing all the doors behind you
  - When outside, ensure that everybody is safely away from the building - at the prearranged assembly point
- Do not leave the assembly point until a head count with your sign-in book/attendance log is completed
- Do not re-enter the premises until we are told it is safe to do so.

## Think about:

How will a parent with a few small children manage an evacuation, will some of the children need to be carried - practice this type of situation when you are having a fire drill.







## Note:

All group members are responsible for ensuring that nothing blocks exits. All escape routes must be kept clear at all times.

# Infectious Illness

See page 27



Condition	This disease is spread by:	Early Symptoms	Time between exposure and sickness	Exclusion from groups or pre-school
<b>Rashes and skin infections</b>				
Chicken Pox 	Coughing sneezing and contact with weeping blisters	Fever and spots with a blister on top of each spot	10-21 days after being exposed	1 week from appearance of rash, or until all blisters have dried
Hand, foot and mouth disease	Coughing, sneezing, and poor hand washing	Fever, flu-like symptoms—rash on soles and palms and in the mouth	3 – 5 days	Exclude until blisters have dried. If blisters able to be covered, and child feeling well, they will not need to be excluded
Head lice (nits)	Direct contact with infested person's hair	Itchy scalp, especially behind ears.	N/A	None. But setting should be informed. Treatment recommended to kill eggs and lice
Scabies	Contact with infected skin, bedding and clothing	Itchy rash	4-6 weeks (but if had scabies before it may develop within 1-4 days)	Exclude until the day after appropriate treatment
Impetigo (school sores)	Direct contact with infected sores	Blisters on the body which burst and turn into scabby sores	Variable	Until sores have dried up or 24 hrs after antibiotic treatment has started
<b>Diarrhoea &amp; Vomiting illnesses</b>				
Gastroenteritis, Salmonella, 	Undercooked food, contaminated water. Direct spread from an infected person or animal.	Stomach pain, fever, nausea, diarrhoea and/or vomiting	6-72 hours	Until well and 48 hours after last episode of diarrhoea or vomiting Salmonella— discuss exclusion of cases and contacts with public health services
<b>Respiratory Infections</b>				
Influenza and flu like illness	Coughing and sneezing. Direct contact with infected person	Sudden onset of fever with cough, sore throat, muscular aches and a headache	1-4 days (average about 2 days)	Until well
Streptococcal sore throat 	Contact with secretions of a sore throat. (coughing, sneezing etc)	Headache, vomiting, sore throat.	1-3 days	Exclude until well and/or has received antibiotic treatment for at least 24 hours
<b>Other Infections</b>				
Conjunctivitis	Direct contact with discharge from the eyes or with items contaminated by the discharge	Irritation and redness of the eye. Sometimes there is a discharge	2-10 days (usually 3-4 days)	While there is discharge from the eyes
Pregnant women should seek from their maternity provider or G.P. 				
Vaccine—preventable  Notifiable disease  				

For the sake of the group and yourself if you or your child is unwell, its better to stay at home.

# Control of Infectious Diseases



We would ask all participants to kindly absent themselves from group in the unfortunate event that a parent/carer or child are not feeling well e.g. the common cold, stomach bugs flu, measles, mumps, chicken pox, head lice etc.

To maintain a high standard of hygiene:

- Toys and equipment need to be washed regularly
- Have a supply of hand soap, baby wipes, nappy disposal bags and paper towels
- Accompany children to the toilet and supervise hand washing
- Clean changing mat after each use

Think about safe healthy option when choosing snacks and drinks.



# Supervision Policy – keeping everyone safe

It is important that everyone enjoys their time in xxxx Baby & Toddler group and to ensure this happen please remember that your child's safety and well-being remain your responsibility at all times.

- Sometime there are art & craft activities which may involve small pieces, please be very careful and ensure none of the children get the opportunity to eat these
- Our group offers parents tea and coffee please be vigilant and ensure none of our small people get burnt
- We have a small baby area to help keep out littlest members safe, if your toddler would like to visit the baby area please remain with them as something toddlers haven't learnt yet how to be gentle or simply forget
- If your little one needs to use the toilet please accompany them and keep them company
- Sometime we like to organise outings on these events we have a ratio of one adult to two children, if you have more children please bring someone along to help you
- Its lovely when babies have a little nap in their buggy during the session can you keep a regular check on sleeping babies.

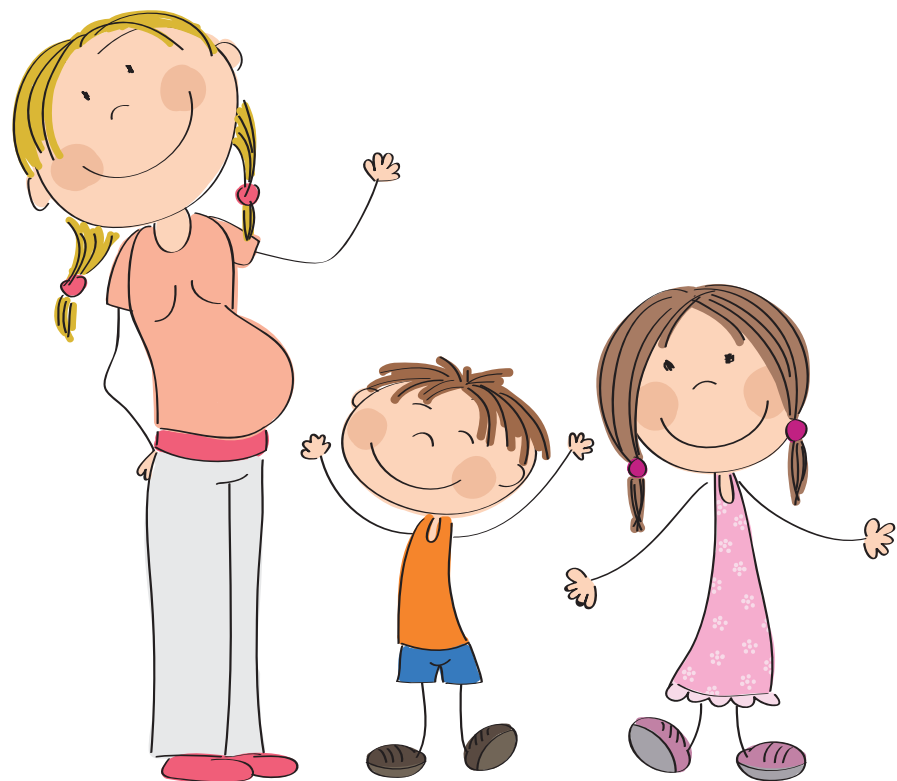

# Sample Risk Assessment Checklist

(Tick after check has taken place and approved)

Group name:

Date:

1. Are all socket covers in place (especially low sockets)?
2. Is access restricted to the kitchen, stairways and stage area (if applicable)?
3. Is all kitchen equipment out of the reach of the children?
4. Have all cupboard doors been closed?
5. Are all windows closed/open to provide a comfortable temperature in the room and safety for users?
6. Are safety door locks in place to prevent children escaping from the room and strangers to enter the room without relevant permission?
7. Are toilets clean and ready for use?
8. Are floors clean and undamaged?
9. Are radiators/heaters covered or measures taken to prevent accident/injury?
10. Is the first aid box available and intact?
11. Is the accident book available?
12. Is the emergency phone in working order?
13. Are fire extinguishers secure, not missing and in date?
14. Are exits & fire exits open and clear from obstructions?
15. Is play equipment clean and undamaged?
16. Are safety mats in place under slides or climbing equipment?
17. For outside areas only - Has the area been checked for litter/ animal faeces and made secure for play?

Checker's initials

Comments

# Accident/Injury/Incident Form



Accident/Injury/Incident Forms are kept by

(Group Leader or Safety Person)

in a secure place. Copies may be furnished to our insurers should the need arise, encourage parents/carers to take a photo of the completed form.

## 1. Personal details:

Name:  Date of Birth:

Address:

## 2. Accident/Incident details :

Date & Time of accident/incident:

Details of accident/incident:  
(use separate sheet if required)

Location:

Who was present at the time of above accident/incident?  
(This should include names of other adults, children etc.)

## Action taken and by whom:

Comments of parent/carer at the time of accident/incident

Signed:	Parent/Carer:	Date:	Tel:
---------	---------------	-------	------

Signed:	Group leader:	Date:	Tel:
---------	---------------	-------	------

Signed:	Witness:	Date:	Tel:
---------	----------	-------	------

## Note:

It is important for all groups to keep an accident and incident record book for insurance purposes.

All accidents must be recorded while the events are fresh in members' minds so that if a claim should eventuate all the details are available.

Details should include date, time and place, people present, action taken and signatures.

Contact the insurance broker immediately to advise of any incidents or injuries that could conceivably give rise to an insurance claim.

# Disclaimer – keeping everyone safe

**abc start right LIMERICK**

**MOMS & DADS ARE ALWAYS IN CHARGE**

A BIG THANK YOU TO YOURSELF AND YOUR CHILD FOR BEING PART OF OUR ABC START RIGHT ACTIVITY TODAY. WE ARE SO HAPPY TO HAVE YOU WITH US!

ALL OF THE WORK (FUN THINGS!) THAT THE ABC START RIGHT TEAM DOES IS ABOUT SUPPORTING YOUR RELATIONSHIP WITH YOUR CHILD. WE CAN RUN ACTIVITIES, GIVE IDEAS AND ANSWER ANY QUESTIONS THAT YOU HAVE. WE CAN'T, HOWEVER, KEEP OUR EYES ON YOUR CHILD.

THANK YOU FOR HELPING US TO KEEP ALL OUR ACTIVITIES SAFE. NOW, LET'S GET BACK TO THE FUN STUFF.

JUST A GENTLE REMINDER THAT YOUR CHILD'S SAFETY AND WELL-BEING IS YOUR RESPONSIBILITY. GROUPS AND WORKSHOPS ARE LIVELY AND BUSY SO PLEASE MAKE SURE YOU KNOW WHERE YOUR SMALL PERSON IS AT ALL TIMES.

[www.loveparenting.ie](http://www.loveparenting.ie)

The Area Based Childhood Programme 2013-2017

Find us on Facebook: ABC Start Right Limerick  
#ABCStartRight

A big thank you to yourself and your child for being part of our xxxx activity today. We are so happy to have you with us!

Moms & Dads are always in charge

All the work (fun things!) that the group does is about supporting relationships with your child. We can run activities, give ideas and answer any questions that you may have. We can't however keep our eyes on your child.

Just a gentle reminder that your child's safety and well-being is your responsibility. Groups and workshops are lively and busy so please make sure you know where your small person is at all times.

Thank you for helping us to keep all our activities safe. Now, let's get back to some fun stuff.

# Outings Policy

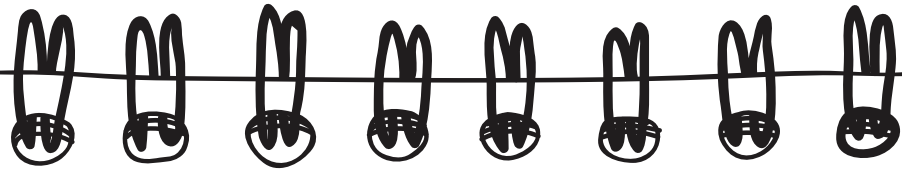

We

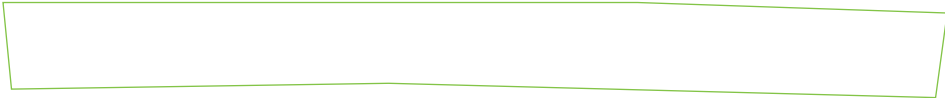

enjoy going out on outing from time to time as a Baby & Toddler group and we love when our parents, carers and guardians become involved in the planning of these outings.

Outings are chosen by the group based on popularity and safety considerations. We have a ratio of one adult to two children, if you have more children please bring someone along to help you.

We always contact our insurance company before going on the outing to ensure the outing will be covered by our insurers.

If we use a bus on an outing we will ensure that all seats will be fitted with safety belts and you will be asked to bring along your own car seat to make sure we all get there safely.

During these outing please keep an extra eye on your child/ren in case they try to wonder off.

Also please let us know if you decide to head home early in case we spend time looking for you later in the day.

# Bibliography

Dublin South West Inner City NEYAI Consortium *Stay & Play Facilitators Guide – A Guide to Setting up Community-Based ‘Stay & Play’ Groups for Children 0 – 3 years & their Parents* (2012)

Galway City & County Childcare Committee, *Parent and Toddler Information Pack* (2011)

Health Ministry (New Zealand Government), *Infectious Diseases: Information & Exclusion List* (2016)

Health Service Executive, *Management of Infectious Disease in Childcare Facilities and Other Childcare Settings* ([www.hse.ie](http://www.hse.ie))

National Literacy Trust, *Bilingual Children: Quick Tips for Parents and Carers* (2017)

Offaly County Childcare Committee Ltd. *Parent and Toddler Information Pack* (2008 & 2013)

Wales Preschool Providers Association, *Parent and Toddler Group Guidelines* (2016)

Playgroup WA (Western Australia), *Playgroup Manual* (2017)

# Websites

[www.kerrycountychildcare.com](http://www.kerrycountychildcare.com)

[www.cccw.ie/](http://www.cccw.ie/) (Waterford)

[www.donegalchildcare.com](http://www.donegalchildcare.com)

[www.earlychildhoodireland.ie](http://www.earlychildhoodireland.ie)

[www.tusla.ie](http://www.tusla.ie)

[www.loveparenting.ie](http://www.loveparenting.ie)

[www.dataprotection.ie/](http://www.dataprotection.ie/)

[www.pinterest.ie/kathrynralstono/early-years-research/?lp=true](http://www.pinterest.ie/kathrynralstono/early-years-research/?lp=true) (The Early Years Institute posters)

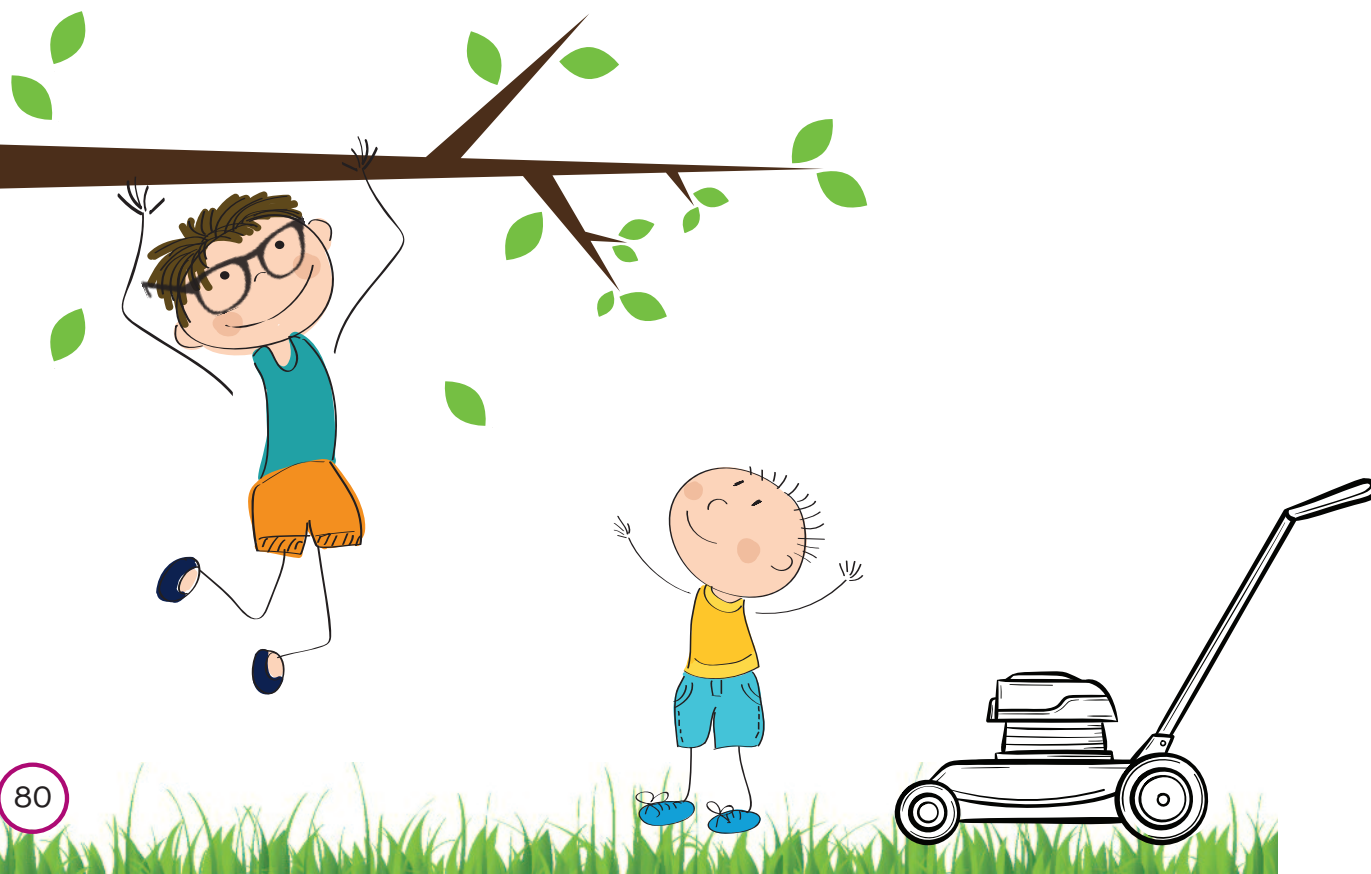

# Notes

